

BUYING GUIDE

Children's sleep 3+ years

Beds, mattresses and accessories

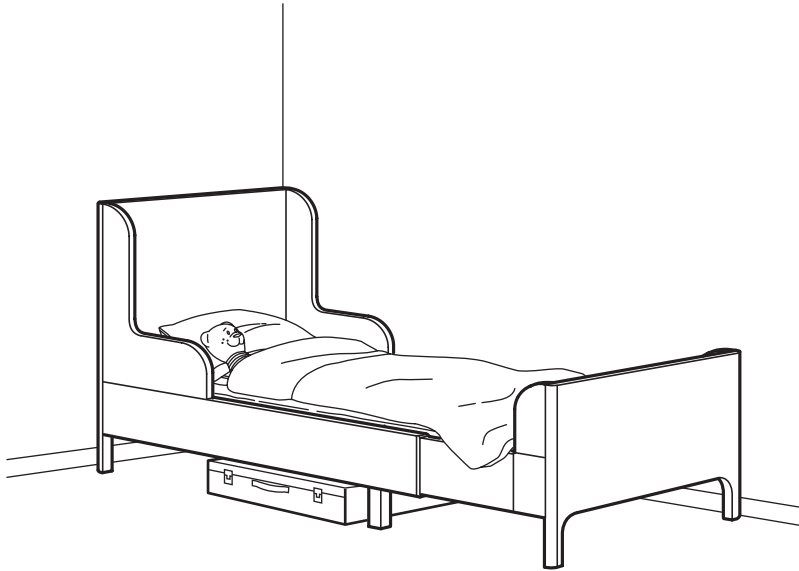

Time for a new bed?

Children are constantly on the move, learning new things, experimenting and playing. That's why they need a safe place where they can rest and sleep while they process all the impressions from an active day. At this age they've probably outgrown their cot, and a bed for adults seems much too big. This is when a children's bed is perfect. Just the right size to feel both snug, cosy and safe.

All the products (shown here) may not be available at the store. Please contact the staff or look at www.IKEA.co.id for more information. For more detailed product information, see the price tag and the Internet. All units require assembly. IKEA Indonesia reserves the right to adjust our prices, to correct price errors or misprints according to any changes beyond our responsible control. IKEA Indonesia tries to ensure that all information stated is correct at the time of publishing.



MATTRESSES

Like IKEA mattresses for adults, children's mattresses are well ventilated to allow the airflow needed to prevent moisture and mould build-up. Most of our outer mattress covers are washable.

IKEA children's mattresses come in different comfort choices. A mattress needs to be firm enough for the needs of growing bodies, but soft and comfortable on top. All our mattresses are made of safe, durable materials. Free from harmful chemicals and well-ventilated, they provide a healthy and comfortable sleeping environment for your child.

HOW TO CHOOSE A MATTRESS

To find the right mattress for your child, here are some things to consider:

1. Foam or sprung?

We offer a variety of different mattresses. Deciding if you want a foam or a sprung mattress for your child will help you to narrow down your choice considerably.

2. Your budget

We have mattresses to fit every budget – from basic mattresses to mattresses made with high quality materials. But you can be sure that every one of them is designed with your child's safety and healthy sleep as first priority. We never compromise on children's safety.

3. Identify individual needs

Size: Are you buying a mattress for an extendable bed or a junior bed? As the extendable bed "grows" with the child in three steps, the mattress comes in three pieces: Just add a part when you extend the bed.

Time: How many years do you think your child will use the mattress? If you want to use the same mattress from the early years well into childhood, a thicker and more durable mattress will provide better support as your child grows.

4. Choose your mattress

On the following pages you will find all of our children's mattresses on offer, along with detailed facts for each.

Air circulation: All children's mattresses promote good air flow, thanks to carefully considered choices in materials and construction.

CARE AND CLEANING

Cover

All our mattresses have covers that are easy to keep clean and fresh for a long time with easy maintenance.

Mattress

Air the mattress regularly to keep it fresh.



Do not wash



Machine wash normal 40°C



Machine wash warm 60°C



Do not bleach



Do not tumble dry



Flat drying



Do not iron



Iron, low temperature



Iron, medium temperature



Do not dry clean

EXTENDABLE BEDS

Suitable for children age 3+

A bed that grows. The length is adjustable as the child grows taller. At IKEA, we say these beds "grow with the child", i.e., the width remains the same, but the length can be adjusted. For a young child, a small, cosy bed is

comforting after graduating from the cot. And since an extendable bed is like having three sizes in one, it is a good environmental choice as well.

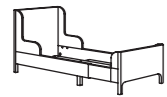
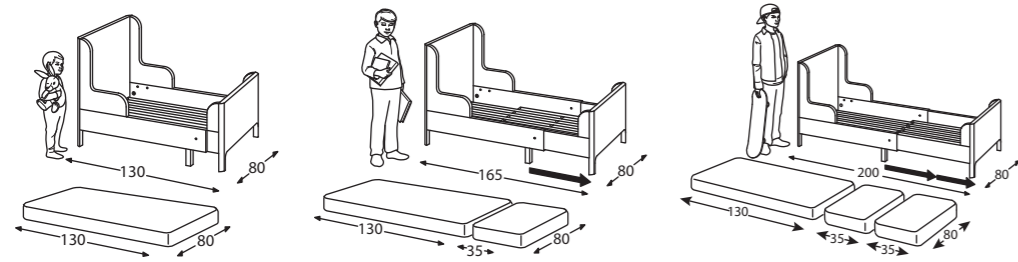

BUSUNGE extendable bed 80x200 cm. The bed can be extended from 80x135 cm to 80x170 cm and 80x200 cm, so it can be pulled out as your child grows. Solid wood slats which offer firm posture support are included.

White	503.513.40	Rp 3.999.000
Light pink	703.513.39	Rp 3.999.000



MINNEN extendable bed 80x200 cm. The bed can be extended from 80x135 cm to 80x170 cm and 80x200 cm, so it can be pulled out as your child grows. LURÖY slatted bed base is included in the price, but is packaged separately.

White	391.246.17	Rp 1.899.000
	092.895.20	Rp 1.899.000

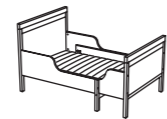

SUNDVIK extendable bed 80x200 cm. The bed can be extended from 80x135 cm to 80x170 cm and 80x200 cm, so it can be pulled out as your child grows. LURÖY slatted bed base is included in the price, but is packaged separately.

White	392.403.39	Rp 3.399.000
Grey-brown	692.403.33	Rp 3.399.000

EXTENDABLE BEDS – COMPLEMENTARY PRODUCTS



LÖVA bed canopy. Can be mounted on the wall above a bed, an armchair etc. Filters the light, creates an atmosphere without blacking out. As a safety precaution, the bed canopy has touch and close fastening that opens easily.

Green	703.384.04	Rp 199.000
-------	------------	-------------------

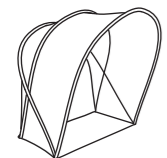

SUFLETT bed tent. Dimensioned to fit 70, 80 and 90 cm wide beds. Do not use in cot.

Green	603.324.74	Rp 300.000
Pink	603.324.69	Rp 300.000

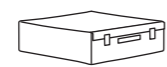

FLYTTBAR bed storage box.

Dark grey	203.288.41	Rp 199.000
-----------	------------	-------------------

MATTRESSES FOR EXTENDABLE BEDS

Suitable for children age 3+

One mattress – three parts. These reversible mattresses grow with your child, just like an extendable bed. Each mattress consists of three parts, one long and two short.

The short pieces are easily added to the foot of the bed as your child grows.

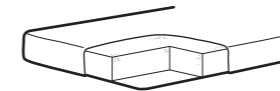

Care instructions



PLUTTEN foam mattress for extendable bed. Simple and safe. This reversible mattress is made of 7 cm thick foam and has the same soft, smooth surface on both sides. The cover can be easily wiped off, and we have roll packed it so it's easy for you to bring home.

80x200 cm	203.504.03	Rp 799.000
-----------	------------	-------------------

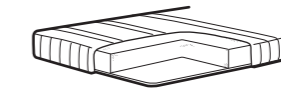

Care instructions

Cover:



NATTSMYG. Flexible and practical. NATTSMYG is a 9 cm thick mattress filled with pressure relieving, elastic, high resilience foam that follows your child's body and provides comfortable support. The long part is easy to carry and put a sheet on as there is a handle on one of the long sides. On the extension parts there are practical touch-and-close fastenings that hold them in place when making the bed. As a bonus, the cover of all three parts of the mattress can be machine washed at 60 °C.

80x200 cm	103.485.85	Rp 1.999.000
-----------	------------	---------------------

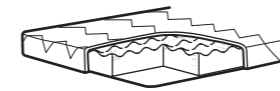

Care instructions

Cover:



VIMSIG foam mattress for extendable bed. Soft and well-ventilated with good support. This 10 cm thick mattress has two different surfaces – one egg-shaped side with medium-firm comfort and one smooth side which is firmer. The texture of the foam makes the mattress comfortable and well-ventilated, which provides good support and a pleasant sleeping environment for your child. The cover can be removed and machine washed at 40°C.

80x200 cm	203.485.75	Rp 999.000
-----------	------------	-------------------

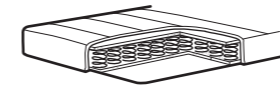

Care instructions

Cover:



INNERLIG sprung mattress for extendable bed. Flexible springs and soft foam. The longer part of this three-piece, 12 cm thick mattress consists of flexible springs enclosed with soft foam. The construction means that the mattress keeps its shape longer, allows air to circulate and provides comfortable support for your child. The two short parts consist of pressure relieving foam. The cover can be removed and machine washed at 60°C.

80x200 cm	003.485.95	Rp 1.499.000
-----------	------------	---------------------

JUNIOR BEDS

Suitable for children age 3+

Junior beds have rounded edges and narrow gaps between bars so children can't get caught. Like all Children's IKEA



SNIGLAR bed frame with guard rail 70×160 cm. Solid wood, a hard-wearing natural material. The guardrail prevents your child from falling out of the bed. LUROY slatted bed base is excluded in the price, and packaged separately.

Birch	104.430.02	Rp 999.000
Slatted bed base	102.850.93	Rp 200.000

beds, the bed base is ventilated and there are no small parts that can come loose.

JUNIOR BEDS – COMPLEMENTARY PRODUCTS



LÖVA bed canopy. Can be mounted on the wall above a bed, an armchair etc. Filters the light, creates an atmosphere without blacking out. As a safety precaution, the bed canopy has touch and close fastening that opens easily.

Green	703.384.04	Rp 199.000
-------	------------	-------------------

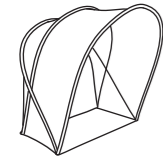

SUFLETT bed tent. Dimensioned to fit 70, 80 and 90 cm wide beds. Do not use in cot.

Green	603.324.74	Rp 300.000
Pink	603.324.69	Rp 300.000

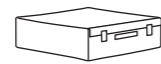

FLYTTBAR bed storage box.

Dark grey	203.288.41	Rp 199.000
-----------	------------	-------------------

MATTRESSES FOR JUNIOR BEDS

Suitable for children age 3+

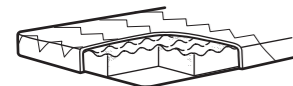

Care instructions

Cover:



UNDERLIG This 10 cm thick mattress has two different surfaces – one egg-shaped side with medium-firm comfort and one smooth side which is firmer. The texture of the foam makes the mattress soft and well-ventilated, which provides good support and a comfortable sleeping environment for your child. The cover can be removed and machine washed at 60°C. The mattress is roll packed so it's easy for you to bring home.

70×160 cm	903.485.53	Rp 799.000
-----------	------------	-------------------

KURA REVERSIBLE BED

Suitable for children age 3-6 years with mattress at the bottom

Suitable for children age 6+ with the mattress on the top, loft bed style

Let the older children sleep upside down! The low KURA bed is ideal for young children, but it also "grows" them. Turn it upside down and you have a high bed with space for a cosy den with pillows below.



KURA reversible bed 90×200 cm. Turned upside down the bed quickly converts from a low to a high bed. Slatted bed base is included.

White/pine	402.538.11	Rp 4.999.000
------------	------------	---------------------



KURA bed tent. Fits the bed both in a low and a high position. A bed canopy gives privacy and creates a room-in-room feeling. Note! Only works with KURA reversible bed.

Turquoise	002.966.00	Rp 500.000
Pink	903.112.29	Rp 500.000

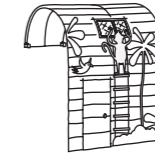

KURA bed tent with curtain. A bed canopy gives privacy and creates a room-in-room feeling. Note! Only works with KURA reversible bed.

Brown	303.938.31	Rp 900.000
-------	------------	-------------------

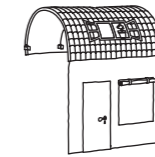

KURA bed tent with curtain. A bed canopy gives privacy and creates a room-in-room feeling. Note! Only works with KURA reversible bed.

Grey/white	703.324.59	Rp 900.000
------------	------------	-------------------

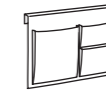

STICKAT bed pocket 39×30 cm. Clever storage solution that you can hang on our children's beds.

Green	202.962.94	Rp 69.900
Pink	702.962.96	Rp 69.900
Black	603.783.39	Rp 69.900

MATTRESSES FOR KURA REVERSIBLE BED

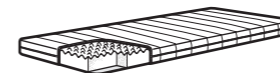

Care instructions

Cover:



MOSHULT foam mattress. White. Get all-over support and comfort with a resilient foam mattress. The 90×200 size is approved for children. It has a child-proof zipper without a pull mechanism, which eliminates small parts and prevents children from opening it. Easy to keep clean since you can wash the cover by machine. Easy to bring home since the mattress is roll packed. Thickness: 10 cm.

90×200 cm	102.723.40	Rp 1.299.000
-----------	------------	---------------------

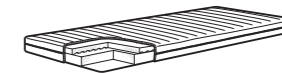

Care instructions

Cover:



MALFORS foam mattress. White. Get all-over support and comfort with a resilient foam mattress. The 90×200 cm size is approved for children. It has a child-proof zipper without a pull mechanism, which eliminates small parts and prevents children from opening it. Easy to bring home since the mattress is roll packed. Easy to keep clean since you can wash the cover by machine. Thickness: 12 cm.

90×200 cm	002.723.12	Rp 1.999.000
-----------	------------	---------------------

STORAGE BEDS AND PULL-OUT BEDS

Suitable for children age 3+

Suitable for children from 3 years. Pull-out beds, also called under-beds, roll on castors and are perfect for making the most of a small space. They slide easily under other



SLÄKT bed frame 90×200 cm. This bed frame can be combined with SLÄKT underbed with storage or with the SLÄKT seat module with storage and SLÄKT storage box with castors. LURÖY slatted bed base is included in the price, but is packaged separately.

White 592.277.56 **Rp1.899.000**



SLÄKT bed frame with underbed and storage, 90×200 cm. The underbed creates an extra sleeping-place under SLÄKT bed frame. The underbed is perfect to roll out when a friend sleeps over and there's room for both bedlinens and toys in the drawers. Max. mattress height in the underbed is 10 cm. LURÖY slatted bed bases are included in the price, but they are packaged separately.

White 492.277.52 **Rp4.899.000**



SLÄKT bed frame with seat module and storage, 90×200 cm. You can combine the SLÄKT bed frame with different modules to create extra storage space or a comfy place for hanging out with friends.

592.397.35 **Rp5.598.000**

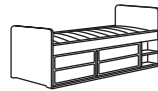

SLÄKT bed frame with storage and slatted bed base, 90×200 cm. A teenager's dream. A nice bed with lots of storage which swallows up everything from t-shirts to hobby things, and not least, dirty laundry. Everything in a small space and at a comfortable distance.

White 992.919.67 **Rp4.499.000**

beds. Some IKEA beds come with space-saving storage built right into the bed.

COMPLEMENTARY PRODUCTS



SLÄKT seat module with storage, 61×61×36 cm. This seat module with storage fits under the SLÄKT bed frame 90×200 cm. Easy to move where it is needed thanks to castors. You can store things under the lid.

Grey 503.629.61 **Rp1.500.000**



SLÄKT storage box with castors 62×62×36 cm. This storage box fits under the SLÄKT bed frame and it is easy to move around thanks to castors. You can store things in the drawer.

White 503.629.75 **Rp1.000.000**



SLÄKT pouffe/mattress, foldable, 62×48×36 cm. Kids love being on a soft mattress on the floor - this one is great for tumbling, lounging or hanging out with friends. When it's time to tidy up just fold it and tuck it away under SLÄKT bed.

Grey 903.629.64 **Rp1.199.000**

GOOD TO KNOW

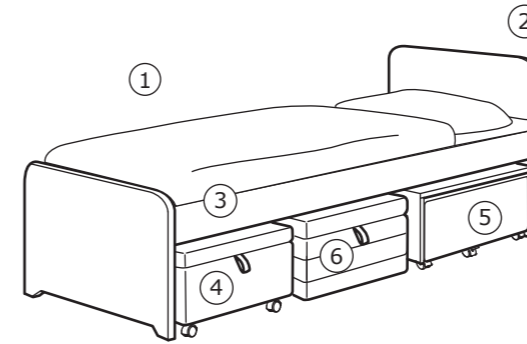

1. Bed frame with space underneath for storage or an under-bed with storage.
2. Rounded corners and edges.
3. LURÖY slatted bed base is included in the price, but packaged separately.
4. Seat module has storage space under the lid and castors underneath.
5. The storage has a drawer for your stuff and it is easy to move thanks to castors.
6. Pouffe/Foldable mattress can be folded out in many different ways for hanging out or laid down flat on the floor like a mattress.

STORAGE BEDS AND PULL-OUT BEDS – COMPLEMENTARY PRODUCTS



LÖVA bed canopy. Can be mounted on the wall above a bed, an armchair etc. Filters the light, creates an atmosphere without blacking out. As a safety precaution, the bed canopy has touch and close fastening that opens easily.

Green 703.384.04 **Rp199.000**

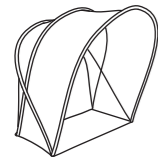

SUFLETT bed tent. Dimensioned to fit 70, 80 and 90 cm wide beds. Do not use in cot.

Green 603.324.74 **Rp300.000**
Pink 603.324.69 **Rp300.000**

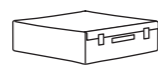

FLYTTBAR bed storage box.

Dark grey 203.288.41 **Rp199.000**

BUNK BEDS AND LOFT BEDS

Suitable for children from 6 years of age

Bunk beds have sleeping for two – an upper bunk and a lower bunk. Loft beds provide sleeping for one, with space underneath for storage, play or study. Both are single beds. Only children over age 6 should sleep in the top bunk. The top bed has a solid guardrail at a good height for the safety

of the top sleeper. Minimal gaps in the rail ensure that the child cannot fall out. But the guardrail loses its function if the mattress is too high up in the bed to make the guardrail protective. So use a mattress that is the right thickness for a loft bed or top bunk.

LOFT BEDS

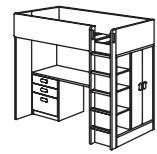

STUVA loft bed combo with 3 drawers/2 doors, 207×99×193 cm.
White 692.534.34 **Rp12.249.000**



STUVA loft bed with desk and storage 90×200 cm. With this loft bed you get a complete solution for your child's room – including desk, wardrobe and open shelf unit. You can assemble the desk parallel or perpendicular to the bed according to your needs. If you choose to assemble the desk perpendicular to the bed, you can access the wardrobe from both sides. To reduce the risk of slipping the ladder has anti-slip grooves. It's easy to keep sockets and cables out of sight but close at hand. Read more about STUVA loft bed with desk and storage in the STUVA buying guide. Bed base included.
White 203.450.96 **Rp9.999.000**



TUFFING loft bed 90×200 cm. You can use the space under the bed for working or studying by completing with SVÄRTA desk top, or create a cosy spot for seating. Bed base included.
102.994.48 **Rp1.999.000**



VITVAL loft bed frame 90×200 cm. It is the details that make this loft bed unique. Soft shapes, sturdy ladder and fabric guardrails with yellow accents. You can also pimp it with bedlinens and accessories from the MÖJLIGHET series.
White/light grey 204.112.32 **Rp4.499.000**



VITVAL desk top 95×45 cm. With this desk, you can easily create a writing space under VITVAL loft bed. The support leg makes it sturdy and you can pimp the pegboard with accessories from the SKÅDIS series. The holes fit perfectly.
White 004.114.12 **Rp1.000.000**



VITVAL loft bed frame + desk top 90×200 cm. It is the details that make this loft bed unique. Soft shapes, fabric guardrails and a desk with a practical pegboard. You can also pimp it with accessories from the MÖJLIGHET and SKÅDIS series.
White/grey 893.039.37 **Rp5.499.000**

BUNK BEDS



SVÄRTA bunk bed frame 90×200 cm. A good solution where space is limited. The ladder mounts on the right or the left side of the bed. Bed base included.
Silver colour 902.479.74 **Rp2.799.000**

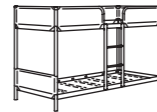

TUFFING bunk bed 90×200 cm. A good solution where space is limited. The bed is lower, which makes it easier to make the bed. Bed base included.
802.392.34 **Rp1.999.000**



MYDAL bunk bed frame 90×200 cm. The ladder mounts on the right or the left side of the bed. Made of solid wood, which is a hardwearing and warm natural material. A good solution where space is limited. Slatted bed base is included.
Pine 003.687.72 **Rp4.999.000**

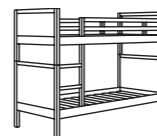

NORDDAL bunk bed frame 90×200 cm. Can be divided into two single beds. The ladder mounts on the right or the left side of the bed.
Pine 104.142.50 **Rp6.999.000**
White 704.142.47 **Rp6.999.000**

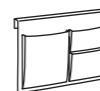

STICKAT bed pocket 39×30 cm. Clever storage solution that you can hang on our children's beds.
Green 202.962.94 **Rp69.900**
Pink 702.962.96 **Rp69.900**
Black 603.783.39 **Rp69.900**

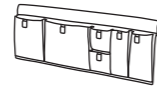

MÖJLIGHET bed pocket 75×27 cm. With this practical bed pocket by the side of the bed, you always have your book, tablet and headphones within easy reach – even if you sleep on the top part of the bunk bed.
Blue 404.213.91 **Rp129.000**



VITVAL bunk bed frame 90×200 cm. Soft shapes and fabric guardrails. These are the details that make this bunk bed unique. Perfect when you need space for two, but have limited space.
White/light grey 604.112.73 **Rp4.999.000**

MATTRESSES FOR BUNK BEDS AND LOFT BEDS

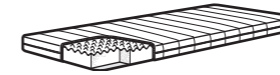

Care instructions

Cover:



MOSHULT foam mattress. White. Get all-over support and comfort with a resilient foam mattress. The 90×200 size is approved for children. It has a child-proof zipper without a pull mechanism, which eliminates small parts and prevents children from opening it. Easy to keep clean since you can wash the cover by machine. Easy to bring home since the mattress is roll packed. Thickness: 10 cm.

90×200 cm 102.723.40 **Rp1.299.000**



Care instructions

Cover:



MALFORS foam mattress. White. Get all-over support and comfort with a resilient foam mattress. The 90×200 cm size is approved for children. It has a child-proof zipper without a pull mechanism, which eliminates small parts and prevents children from opening it. Easy to bring home since the mattress is roll packed. Easy to keep clean since you can wash the cover by machine. Thickness: 12 cm.

90×200 cm 002.723.12 **Rp1.999.000**

