

Beds



A good day always starts with a good night

Feeling your best when you wake up starts with the right bed. In this buying guide, you will find all our beds, including bed frames with and without storage, day-beds, guest beds, loft beds, bunk beds and divan beds. You will also get an overview of our bed accessories, such as headboards and bed storage boxes.

Of course, a bed is not complete without a mattress and bedding. You can test and find the best mattress for you in the mattress studio. The textiles department has a wide range of quilts, pillows and bed linen.



Scan this code to get to the Sleep and Comfort Guide.

All the products (shown here) may not be available at the store. Please contact the staff or look at www.IKEA.co.id for more information. For more detailed product information, see the price tag and the Internet. All units require assembly. IKEA Indonesia reserves the right to adjust our prices, to correct price errors or misprints according to any changes beyond our responsible control. IKEA Indonesia tries to ensure that all information stated is correct at the time of publishing.



Bed frames

A complete bed frame with mattress consist of these parts:

1. Choose a bed frame and size.
2. SKORVA midbeam is needed for most double beds. It is included in the price of the bed frame, but is picked up separately in the self-serve furniture area.
3. For most bed frames, you will also need to choose a slatted bed base.
4. Choose a mattress or use the one you have at home. You can find the best one for you in the mattress studio.
5. Add a mattress pad of your choice for a softer sleeping surface.

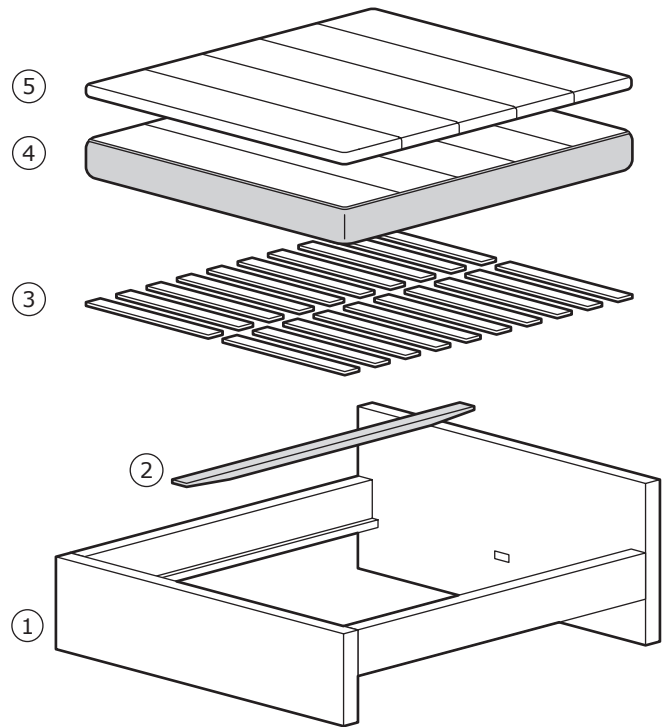

Slatted bed bases

Combined with a bed frame, slatted bed-bases can be used as a base for spring, foam and latex mattresses. They help your mattress last longer and stay comfortable by absorbing most of the stress and weight placed on your bed.

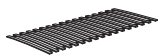

LURÖY slatted bed base. Extend the life of your mattress and get extra support with 17 wooden slats in the bed base.

80x200 cm	002.787.24	Rp 400.000
90x200 cm	801.631.73	Rp 500.000
120x200 cm	801.628.90	Rp 500.000
150x200 cm	002.771.97	Rp 600.000

*For bed frame size 180x200 cm, must use 2 set of LURÖY size 90x200 cm

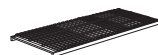

LÖNSEY slatted bed base, fixed. 28 birch slats adjust to your body weight and increase the suppleness of the mattress. Comfort zones adjust to your body.

90x200 cm	302.787.08	Rp 900.000
120x200 cm	102.787.09	Rp 1.200.000
150x200 cm	102.787.14	Rp 1.500.000

*For bed frame size 180x200 cm, must use 2 set of LÖNSEY size 90x200 cm



SKORVA midbeam is needed for most of our double beds. It is always included in the price of the bed frame when needed, but it is picked up separately.

Galvanized	701.705.03	Rp 600.000
------------	------------	-------------------

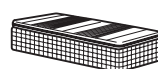

Visit the mattress studio to find the right mattress and mattress pad for you.

ALL BED FRAMES AND PRICES

Slatted bed base not included yet. You must choose LURÖY or LÖNSET. See page 2. Except DELAKTIG, SLATTUM, and NORDLI.



ASKVOLL bed frame, white

150×200 cm	790.197.04	Rp 3.099.000
180×200 cm	690.197.09	Rp 3.299.000



BJÖRKSÅS bed frame, Birch.

150×200 cm	692.475.46	Rp 6.599.000
180×200 cm	792.475.41	Rp 7.599.000



DELAKTIG bed frame.

Slatted bed base is included.

150×200 cm	992.875.31	Rp 6.599.000
------------	------------	---------------------



DELAKTIG bed frame with headboard.

Slatted bed base is included.

With rattan headboard

150×200 cm	392.875.48	Rp 9.598.000
------------	------------	---------------------

With black headboard

150×200 cm	892.875.36	Rp 9.098.000
------------	------------	---------------------



DELAKTIG bed frame with headboard and 2 side tables.

Slatted bed base is included.

With rattan headboard

150×200	992.881.87	Rp 11.598.000
---------	------------	----------------------

With black headboard

150×200	592.881.27	Rp 11.098.000
---------	------------	----------------------

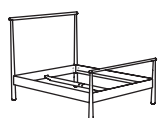

GJÖRA bed frame, birch.

150×200 cm	392.276.82	Rp 5.099.000
------------	------------	---------------------



HEMNES bed frame, stained pine.

White stain

90×200 cm	003.543.84	Rp 2.899.000
150×200 cm	191.983.98	Rp 4.599.000
180×200 cm	091.984.12	Rp 5.299.000

Black brown

90×200 cm	203.543.83	Rp 2.899.000
150×200 cm	491.982.31	Rp 4.599.000
180×200 cm	691.983.91	Rp 5.299.000



KOPARDAL bed frame, grey metal.

120×200 cm	391.576.55	Rp 1.899.000
150×200 cm	991.576.57	Rp 2.599.000
180×200 cm	191.576.75	Rp 2.799.000



LEIRVIK bed frame, white metal.

150×200 cm	492.772.66	Rp 1.899.000
180×200 cm	692.772.70	Rp 2.199.000



GRIMSBU bed frame, SKORVA midbeam not needed for this bed.

Green metal

90×200 cm	404.054.09	Rp 599.000
150×200 cm	204.054.05	Rp 999.000

White metal

90×200 cm	204.583.14	Rp 599.000
150×200 cm	604.583.12	Rp 999.000

Grey metal

90×200 cm	204.587.57	Rp 599.000
150×200 cm	404.587.56	Rp 999.000



SONGESAND bed frame.

White

150×200 cm	792.412.28	Rp 2.399.000
180×200 cm	792.412.33	Rp 2.499.000



MALM bed frame.

White

90×200 cm	202.651.79	Rp 1.899.000
120×200 cm	202.494.86	Rp 2.099.000
150×200 cm	890.052.64	Rp 3.299.000
180×200 cm	099.316.01	Rp 3.499.000

Black brown veneer

90×200 cm	402.651.78	Rp 2.299.000
120×200 cm	002.494.92	Rp 2.499.000
150×200 cm	190.225.54	Rp 3.699.000
180×200 cm	199.311.58	Rp 3.899.000

White stained oak veneer

120×200 cm	403.251.63	Rp 2.499.000
150×200 cm	890.225.55	Rp 3.699.000
180×200 cm	790.225.51	Rp 3.899.000

Brown stained ash veneer

90×200 cm	803.251.56	Rp 2.299.000
120×200 cm	303.251.54	Rp 2.499.000
150×200 cm	591.570.32	Rp 3.699.000
180×200 cm	691.570.36	Rp 3.899.000



NEIDEN bed frame, pine.

SKORVA midbeam not needed for this bed.

90×200 cm	104.503.56	Rp 799.000
150×200 cm	104.514.93	Rp 999.000



NESTTUN bed frame, white metal.

90×200 cm	491.579.90	Rp 1.099.000
120×200 cm	191.579.82	Rp 1.399.000
150×200 cm	791.579.84	Rp 2.099.000
180×200 cm	891.579.88	Rp 2.699.000



ALL BED FRAMES AND PRICES



SAGSTUA bed frame, metal.

White

120×200 cm	092.792.05	Rp 2.399.000
150×200 cm	492.542.60	Rp 3.199.000
180×200 cm	792.542.06	Rp 3.399.000

Black

120×200 cm	292.792.09	Rp 2.399.000
150×200 cm	692.689.11	Rp 3.199.000
180×200 cm	192.688.95	Rp 3.399.000



SLATTUM bed frame, upholstered.

Slatted bed base and midbeam are included.

KNISA grey, fabric

150×200 cm	804.463.75	Rp 2.999.000
180×200 cm	804.463.80	Rp 3.499.000

BOMSTAD black, coated fabric

150×200 cm	704.502.21	Rp 2.799.000
180×200 cm	604.502.26	Rp 3.299.000



TARVA bed frame, pine.

90×200 cm	203.544.63	Rp 1.099.000
120×200 cm	003.544.59	Rp 1.399.000
150×200 cm	391.985.14	Rp 2.099.000
180×200 cm	091.985.77	Rp 2.299.000

TRYSIL bed frame.

White/light grey

150×200 cm	591.985.94	Rp 2.399.000
------------	------------	---------------------



TYSSDAL bed frame, white.

150×200 cm	591.986.07	Rp 6.099.000
180×200 cm	091.986.43	Rp 6.799.000
90×200 cm	003.775.35	Rp 4.099.000
120×200 cm	603.775.37	Rp 4.599.000



MALM bed frame with storage boxes.

White

With 2 storage boxes

90×200 cm	391.992.07	Rp 2.999.000
120×200 cm	991.992.09	Rp 3.199.000

With 4 storage boxes

150×200 cm	191.992.13	Rp 5.499.000
180×200 cm	291.992.17	Rp 5.699.000

Black brown veneer

With 2 storage boxes

90×200 cm	992.003.02	Rp 3.399.000
120×200 cm	391.999.76	Rp 3.599.000

With 4 storage boxes

150×200 cm	591.999.80	Rp 5.899.000
180×200 cm	592.003.304	Rp 6.099.000

White stained oak veneer

With 2 storage boxes

120×200 cm	692.009.35	Rp 3.599.000
------------	------------	---------------------

With 4 storage boxes

150×200 cm	892.009.39	Rp 5.899.000
180×200 cm	392.009.51	Rp 6.099.000

Brown stained ash veneer

With 2 storage boxes

90×200 cm	491.988.20	Rp 3.399.000
120×200 cm	691.988.62	Rp 3.599.000

With 4 storage boxes

150×200 cm	791.988.66	Rp 5.899.000
180×200 cm	291.989.63	Rp 6.099.000



MALM storage bed. Slatted bed base is included, and SKORVA midbeam is not needed for this bed.

Use one of the following mattresses to ensure that the bed will function safely: HÖVÅG, HAMARVIK and HYLLESTAD sprung mattresses.

White

150x200	904.048.03	Rp 6.799.000
180x200	804.048.13	Rp 7.299.000

Black-brown

150x200	104.048.02	Rp 6.999.000
180x200	604.048.09	Rp 7.499.000



NORDLI bed frame with storage.

Slatted bed base is included, and SKORVA midbeam is not needed for this bed.

White

120×202 cm	503.498.56	Rp 4.499.000
160×202 cm	803.498.50	Rp 6.499.000
180×202 cm	003.498.54	Rp 7.499.000

NORDLI bed frame with storage and headboard.

Slatted bed base is included, and SKORVA midbeam is not needed for this bed.

White

160×200 cm	492.414.23	Rp 8.999.000
180×200 cm	792.414.26	Rp 10.199.000

BED FRAMES WITH STORAGE



BRIMNES bed frame with storage.

White

120×200 cm	504.010.43	Rp 2.999.000
150×200 cm	391.981.42	Rp 4.099.000
180×200 cm	491.981.51	Rp 4.299.000



BRIMNES bed frame with storage and headboard, 4 drawers.

White

150×200 cm	791.981.59	Rp 5.899.000
180×200 cm	091.981.67	Rp 6.299.000



ALL BED FRAMES AND PRICES



PLATSA bed frame.			
140x200 cm	904.530.87	Rp4.950.000	

You can add PLATSA frames to the bed frame to solve your storage needs. Here are 2 of our favourite combinations. Find more in PLATSA buying guide. Slatted bed base, legs and SPILDRA top are included. SKORVA midbeam is not needed for this bed. Complete with 120x200 cm or 140x200 cm mattresses.



PLATSA bed frame with 10 drawers.			
	493.030.29	Rp9.950.000	



PLATSA bed frame with 2 door+3 drawers.			
	993.030.84	Rp9.270.000	



SONGESAND bed frame with storage boxes.			
With 4 storage boxes			
150x200 cm	692.413.23	Rp4.199.000	
180x200 cm	592.413.28	Rp4.299.000	

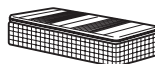

Visit the mattress studio to find the right mattress and mattress pad for you.

ALL BED FRAMES AND PRICES

DAY-BED FRAMES

Day-beds extend to a double bed that is 160 cm wide. Complete the day-bed with two MOSHULT or MALFORS foam mattresses, 80×200 cm or two HUSVIKA spring mattresses, 80×200 cm. Slatted bed base is included and SKORVA mid beam is not needed for day beds.



BRIMNES day-bed frame.

White
80/160×200 cm 503.544.85 **Rp3.999.000**



FLEKKE day-bed frame.

White
80/160×200 cm 403.201.32 **Rp4.999.000**

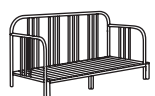

FYRESDAL day-bed frame, black.

80/160×200 cm 004.243.63 **Rp2.999.000**



HEMNES day-bed frame, white.

80/160×200 cm 703.493.27 **Rp5.499.000**



UTÅKER stackable bed, set of 2, pine
80×200 cm 703.604.85 **Rp2.499.000**



LOFT BED FRAMES

Complete the loft bed with a mattress in a matching size. Each model has a maximum mattress thickness (for safety reasons) and a minimum required ceiling height* (see below). High beds and the upper bed of bunk or loft beds are not suitable for children under 6 years due to the risk of injury from falls. Slatted bed base is included and SKORVA mid beam is not needed for loft beds.



STORÅ loft bed frame, black stained pine.

The ladder mounts on the right or the left side of the bed.

*Maximum mattress thickness: 19 cm.
Minimum ceiling height required: 270 cm.

140×200 cm
Black 001.608.66 **Rp5.999.000**
White stain 702.420.86 **Rp5.999.000**



TUFFING loft bed frame

*Maximum mattress thickness: 10 cm.

90×200 cm 102.994.48 **Rp1.999.000**



STUVA loft bed frame with desk and storage, white.

*Maximum mattress thickness: 20 cm.
Minimum ceiling height required: 240 cm.

90×200 cm 203.450.96 **Rp9.999.000**

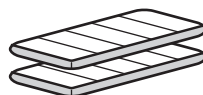

BUNK BED FRAMES

Complete the bunk bed frame with 2 mattresses, 90×200 cm. For safety reasons, each model has a maximum mattress thickness* (see below). High beds and the upper bed of bunk or loft beds are not suitable for children under 6 years due to the risk of injury from falls. Slatted bed base is included and SKORVA mid beam is not needed for Bunk beds.

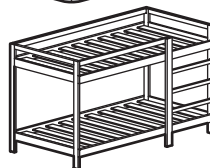

SVÄRTA bunk bed frame, 90×200 cm.

The ladder mounts on the right or the left side of the bed.

*Maximum mattress thickness: 22 cm.

Silver 902.479.74 **Rp2.799.000**



MYDAL bunk bed frame, pine.

The ladder mounts on the right or the left side of the bed.

*Maximum mattress thickness: 19 cm.

90×200 cm 003.687.72 **Rp4.999.000**



NORDDAL bunk bed frame.

The ladder mounts on the right or the left side of the bed. *Maximum mattress thickness: 14 cm.

Pine 90×200 cm 104.142.50 **Rp6.999.000**
White 90×200 cm 704.142.47 **Rp6.999.000**

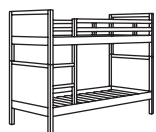

TUFFING bunk bed frame, grey.

The ladder mounts on the right or the left side of the bed.

*Maximum mattress thickness: 12 cm.

90×200 cm 802.392.34 **Rp1.999.000**

ALL PARTS AND PRICES

HEADBOARDS

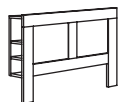

BRIMNES headboard, white.

White		
150 cm	002.759.28	Rp 1.800.000
180 cm	402.287.13	Rp 2.000.000



NORDLI headboard, wall mounted.

White		
90 cm	103.727.64	Rp 1.900.000
140-160 cm	303.729.80	Rp 2.500.000
180-193 cm	703.727.61	Rp 2.700.000



BED STORAGE BOXES



RÖMSKOG bed storage box, 65×70 cm.

Rattan	203.298.93	Rp 1.299.000
--------	------------	---------------------



MALM bed storage box, 2 pack.

White	003.544.97	Rp 1.100.000
Black brown	603.544.99	Rp 1.100.000
White stained oak veneer	403.545.08	Rp 1.100.000
Brown stained ash veneer	203.544.96	Rp 1.100.000



VARDÖ bed storage box. 65×70 cm.

White	903.545.15	Rp 599.000
Black	203.545.14	Rp 599.000

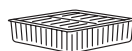

GIMSE bed storage box, 65×70 cm.

White	802.226.67	Rp 249.000
-------	------------	-------------------



SONGESAND bed storage boxes, set of 2.

White	103.725.37	Rp 900.000
-------	------------	-------------------

