

BUYING GUIDE

Table bar

SAFETY

All table tops, trestles, legs and underframes are tested and approved for a maximum load of 50 kg.

Tempered glass should be handled with care! A damaged edge or a scratched surface can cause the glass to crack suddenly. However, only into small pieces, never into sharp fragments. A thin plastic film keeps the pieces of glass in place.

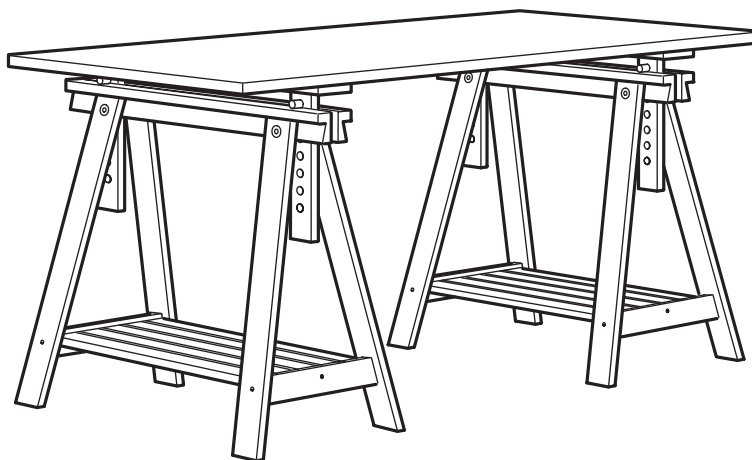

Build your own desk

Create a personal desk that perfectly suits your needs and your style. It can become anything from a desk with drawers to a dining table for the entire family.

All the products (shown here) may not be available at the store. Please contact the staff or look at www.IKEA.co.id for more information. For more detailed product information, see the price tag and the Internet. All units require assembly. IKEA Indonesia reserves the right to adjust our prices, to correct price errors or misprints according to any changes beyond our responsible control. IKEA Indonesia tries to ensure that all information stated is correct at the time of publishing.



HOW TO BUILD

TABLE TOP WITH LEGS



TABLE TOP WITH STORAGE



GLASS TOP WITH TRESTLE

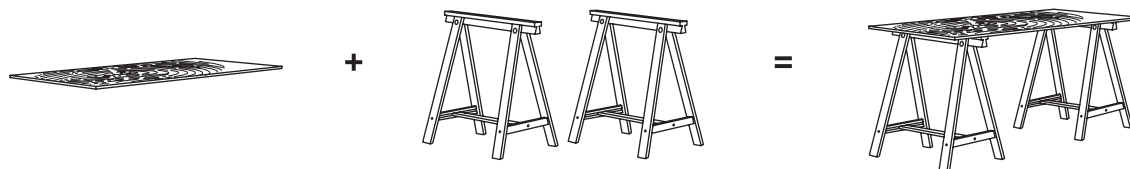

Maximum variety

Choose between table tops in different sizes and shapes. In black, white or bright colours. Add legs that are fixed, height adjustable or on castors – or choose trestles instead. And there are many different styles to choose from. On the last page in this folder you can see all the possible combinations. Have fun choosing your favourite!

COMBINATIONS

There are many more combinations than shown here. Create one that fits your needs and style!

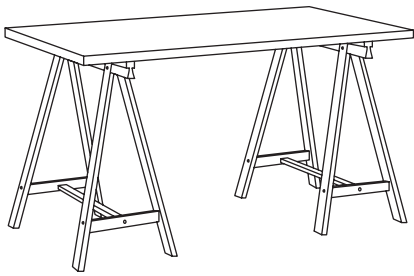

LINNMON/ODDVALD: Choose a table top and trestles that suit your needs as well as your wallet.
Overall size 150×75 cm, height 74 cm.
This combination in white Rp1.289.000



KLIMPEN/LALLE: Create a table that looks just as good in the dining room as it does in the office.
Overall size 120×60 cm, height 73 cm.
This combination Rp2.479.000

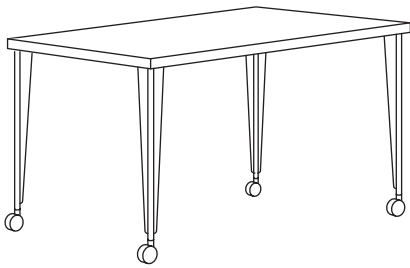

LINNMON/KRILLE: Legs with castors make the table easy to move where needed.
Overall size 120×60 cm, height 74 cm.
This combination in white Rp1.389.000

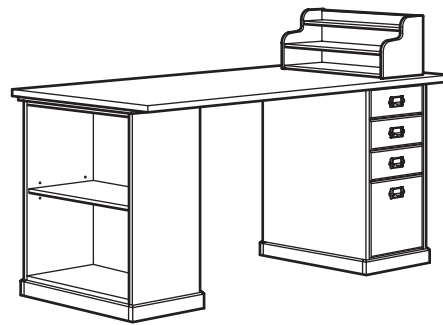

KLIMPEN: With a drawer unit, legs with storage and an add-on unit you have easy access to your papers, binders and supplies and can keep it all well-organised.
Overall size 150×75 cm, height 73 cm.
This combination Rp5.499.000



ÅMLIDEN/TORSKLINT: Create a soft atmosphere in your work space with the rounded edges of the table.
Overall size: 120×60 cm, height 70 cm.
This combination Rp2.279.000

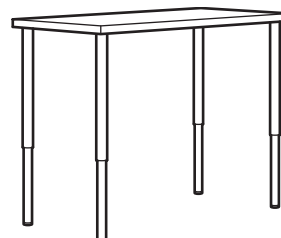

LINNMON/OLOV: If you would like to stand by your desk. You can mount the table top at a height that suits you, since the legs are adjustable between 60-90 cm.
Overall size 120×60 cm.
This combination in white Rp1.229.000

COMBINATIONS



GLASHOLM/ODDVALD: Create a table that blends in with the style in the rest of your home.
Overall size 148×73 cm cm, height 71 cm.
This combination Rp1.779.000

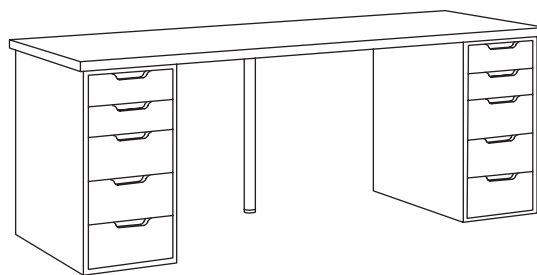

LINNMON/ALEX: A long table top makes it easy to create a workspace for two.
Overall size 200×60 cm, height 74 cm.
This combination in white Rp3.449.000

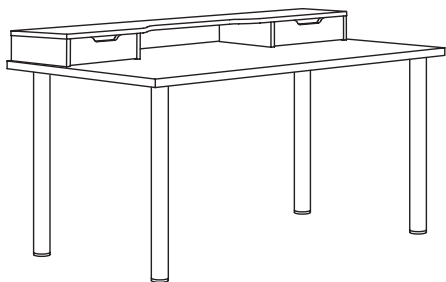

LINNMON/ADILS/ALEX: Create easy access storage and handy place for pens and papers as the add-on unit with 2 roomy drawers simply attaches to the table top.
Overall size 120×60 cm, height 74 cm.
This combination in white Rp1.349.000



HILVER/HILVER: A table top with a surface of bamboo is both durable and sustainable, as bamboo is a fast-growing natural material.
Overall size: 140×65 cm, height 73 cm.
This combination Rp3.139.000



LINNMON/ALEX: Can be placed in the middle of a room because the back is finished.
Overall size 150×75 cm.
This combination in white Rp1.999.000

TABLE TOPS – ALL PARTS AND PRICES



GLASHOLM table top 148×73 cm. Create a table with your own personal touch by complementing with trestles or storage units, available in several colours and styles. Cannot be combined with legs.

Glass/honeycomb pattern 603.537.44 **Rp999.000**



LINNMON table top 100×60 cm. For easy assembly there are pre-drilled holes for legs.

White 003.617.56 **Rp209.000**
Black-brown 603.611.74 **Rp309.000**



LINNMON table top 120×60 cm. For easy assembly there are pre-drilled holes for legs.

White 503.611.79 **Rp309.000**
Beige 403.537.35 **Rp409.000**
Black-brown 903.611.77 **Rp409.000**
Blue 303.537.31 **Rp409.000**
White stained oak effect 603.537.39 **Rp409.000**
Geometric beige 403.537.59 **Rp459.000**
Geometric blue 003.537.56 **Rp459.000**



LINNMON table top 150×75 cm. For easy assembly there are pre-drilled holes for legs.

White 803.611.87 **Rp509.000**
Beige 003.537.37 **Rp609.000**
Black-brown 203.611.85 **Rp609.000**
Blue 903.537.33 **Rp609.000**
White stained oak effect 403.537.40 **Rp609.000**

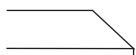

LINNMON table top 200×60 cm. To be completed with 1 extra leg for increased stability. For easy assembly there are pre-drilled holes for legs.

White 403.611.89 **Rp649.000**
Black-brown 603.611.88 **Rp899.000**



GERTON table top 155×75 cm. For easy assembly there are pre-drilled holes for legs. Solid wood, a durable natural material.

Beech 301.622.46 **Rp1.799.000**



HILVER table top 140×65 cm. For easy assembly there are pre-drilled holes for legs. Surface made from bamboo, a durable, renewable and sustainable material.

Bamboo 202.782.85 **Rp1.699.000**



KLIMPEN table top 120×60 cm. For easy assembly there are pre-drilled holes for legs.

Grey 603.563.42 **Rp1.199.000**



KLIMPEN table top 150×75 cm. For easy assembly there are pre-drilled holes for legs.

Grey 103.537.46 **Rp1.399.000**



ÅMLIDEN table top 120×60 cm. For easy assembly there are pre-drilled holes for legs.

Grey-Green 703.654.64 **Rp799.000**



ALEX add-on unit 120×10 white. Easy to create a handy place for pens and papers as the add-on unit with 2 roomy drawers simply attaches to the table top.

White 003.542.56 **Rp800.000**

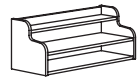

KLIMPEN add-on unit 58×23 cm. Can be placed on a table top or hung on a wall.

Grey 803.537.62 **Rp500.000**



SIGNUM cable trunking horizontal 70×16 cm.

To be attached under the table top. Collects your electric and computer cables together. Cannot be used for glass tops.

Silver-colour 102.002.54 **Rp185.000**

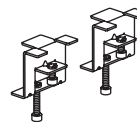

LINNMON connection fitting, 2-p. You can use the connection fitting to attach any non-glass table top in our range to an KALLAX shelf unit.

Nickel-plated 202.610.58 **Rp110.000**

LEGS – ALL PARTS AND PRICES



ADILS leg, 1-p. Height 70 cm. Adjustable feet make the table stand steady also on uneven floors.

White	802.179.77	Rp 60.000
Beige	003.537.42	Rp 60.000
Black	002.179.76	Rp 60.000
Silver-coloured	202.179.75	Rp 60.000
Blue	303.263.04	Rp 60.000



ALEX storage unit, W36xD58xH70 cm. The shelf inside can be adjusted or removed so you can store things of different sizes, from papers to your computer. Cable outlet for easy cable management.

Design: Johanna Asshoff

White	703.542.67	Rp 770.000
-------	------------	-------------------



HILVER leg cone-shaped, 1-p. Height 70 cm. Bamboo is a hardwearing natural material.

Bamboo	502.782.84	Rp 360.000
--------	------------	-------------------



KLIMPEN drawer unit, W33xD58xH70 cm.

This unit can be placed anywhere in the room because it is finished on the back.

Grey	403.537.64	Rp 2.000.000
------	------------	---------------------



KRILLE leg with castor, 1-p. Height 70 cm. Lockable castors make the table easy to move and lock in place. Design: Francis Cayouette.

White	102.502.58	Rp 270.000
-------	------------	-------------------



KLIMPEN table leg with storage, W58xD33xH70 cm. The shelf can be adjusted so you can store things of different sizes.

Grey	903.537.66	Rp 1.600.000
------	------------	---------------------



LALLE leg 1-p. Height 70 cm. Solid wood, a durable natural material. Design: Tina Christensen.

Black	802.378.38	Rp 320.000
-------	------------	-------------------



FINNVARD trestle with shelf, W46xD70xH71-93 cm. Adjustable to different positions for flat or angled table top. Solid wood, a durable natural material.

Birch	503.611.55	Rp 500.000
-------	------------	-------------------



GERTON leg, 1-p. Height 67-107 cm. You can mount the table top at a height that suits you, since the legs are adjustable.

Chrome-plated	402.616.27	Rp 550.000
---------------	------------	-------------------



LERBERG trestle, W60xD39xH70 cm. To be completed with a table top that is minimum 120 cm long.

Grey	301.677.91	Rp 220.000
------	------------	-------------------

White	801.666.71	Rp 220.000
-------	------------	-------------------



OLOV leg, 1-p. Height 60-90 cm. You can mount the table top at a height that suits you, since the legs are adjustable.

White	702.643.04	Rp 230.000
-------	------------	-------------------

Black	902.643.03	Rp 230.000
-------	------------	-------------------



ODDVALD trestle, W42xD70xH70 cm. Solid wood, a durable natural material.

Black	703.612.01	Rp 390.000
-------	------------	-------------------



ALVARET leg, 1-p. Height 70 cm. This hexagonal shaped leg is made in solid wood, which is a durable and natural material. Design: Jomi Evers Solheim.

Grey	403.554.47	Rp 310.000
------	------------	-------------------



TORSKLINT leg, 1-p. Height 70 cm. With its different shape design, this leg adds a rounder and softer feeling to the table tops.

Light Grey	703.781.12	Rp 370.000
------------	------------	-------------------



ALEX drawer unit, W36xD58xH70 cm. This unit can be placed anywhere in the room because it is finished on the back. Design: Johanna Asshoff.

White	103.542.65	Rp 1.370.000
-------	------------	---------------------

Grey	403.542.64	Rp 1.370.000
------	------------	---------------------

GOOD TO KNOW

To make it easy for you to build your own desk, we've planned some things in advance.

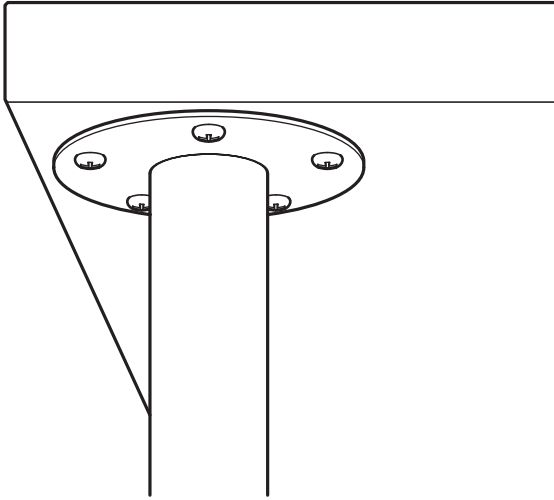







Pre-drilled holes







We have pre-drilled holes in all table tops, so it's easy for you to attach the legs. And we placed the holes close to the edge of the table top so you will have more room under the table, for your legs or a drawer unit. Screws for fixing the legs to the table top are included.

The trestles are extra stable, and don't even need to be attached to the table top. All this to make it easy to create the perfect table for you and your family!

HOW TO COMBINE

	 ADILS 70 cm	 ALVARET 70 cm	 HILVER 70 cm	 KRILLE 70 cm	 LALLE 70 cm	 GERTON 70-107 cm	 OLOV 60-90 cm
GLASHOLM 148x73 cm							
LINNMON 100x60 cm	●	●	●	●	●	●	●
LINNMON 120x60 cm	●	●	●	●	●	●	●
LINNMON 150x75 cm	●	●	●	●	●	●	●
LINNMON 200x60 cm*	●	●	●	●	●	●	●
GERTON 155x75 cm	●	●	●	●	●	●	●
HILVER 140x65 cm	●	●	●	●	●	●	●
KLIMPEN 120x60 cm	●	●	●	●	●	●	●
KLIMPEN 150x75 cm	●	●	●	●	●	●	●
ÄMLIDEN 120x60 cm	●	●	●	●	●	●	●

*Note! An extra leg is needed for stability.

	 ALEX 36x58x70 cm	 ALEX 36x58x70 cm	 KLIMPEN 33x58x70 cm	 KLIMPEN 58x33x70 cm	 FINNVARD 46x70x71-93 cm	 LERBERG 39x60x70 cm	 ODDVALD 42x70x70 cm
GLASHOLM 148x73 cm	●	●	●	●	●	●	●
LINNMON 120x60 cm	●	●	●	●		●	
LINNMON 150x75 cm	●	●	●	●	●	●	●
LINNMON 200x60 cm*	●	●	●	●		●	
GERTON 155x75 cm	●	●	●	●	●	●	●
HILVER 140x65 cm	●	●	●	●		●	
KLIMPEN 120x60 cm	●	●	●	●		●	
KLIMPEN 150x75 cm	●	●	●	●	●	●	●
ÄMLIDEN 120x60 cm	●	●	●	●	●	●	●