

# LAGAN



Design and Quality  
IKEA of Sweden





Please refer to [www.IKEA.com](http://www.IKEA.com)  
and select your local store for local  
store phone numbers and opening  
times.

## ENGLISH

## Contents

Safety Information	4	What to do if ...	10
Use	7	Technical data	11
Product description	8	Environmental concerns	12
Control panel	8	<b>IKEA GUARANTEE</b>	13
Cleaning and maintenance	8		

## Safety Information

### Before first use

Your safety and that of others is paramount.

Remove cardboard protection pieces, protective film and adhesive labels from accessories.

Check the appliance for any transport damage.

To avoid any damage do not place any weights on the appliance. Do not expose the appliance to atmospheric agents. This manual and the appliance itself provide important safety warnings, to be read and observed at all times.

 This is the attention symbol, pertaining to safety, which alerts users to potential risks to themselves and others.

All safety warnings are preceded by the attention symbol and the following terms:

 **DANGER:** indicates a hazardous situation which, if not avoided, will cause serious injury.

 **WARNING:** Indicates a hazardous situation which, if

not avoided, could cause serious injury.

All safety warnings give specific details of the potential danger/warning present and indicate how to reduce risk of injury, damage and electric shock resulting from improper use of the appliance. Carefully observe the following instructions.

### Precautions and general recommendations

- The electrical installation and the electrical connection must be carried out by a qualified technician according to the manufacturer's instructions and in compliance with the local safety regulations. Do not repair or replace any part of the appliance unless specifically stated in the user manual.
- The appliance must be disconnected from the power supply before carrying out any installation work.

 **WARNING:** Failure to install the screws or fixing device in accordance with these instructions may result in electrical hazards.

- Earthing of the appliance is compulsory. (Not possible for class II hoods identified by the symbol  on the dataplate).
- Do not pull the power supply cable in order to unplug the appliance.
- The electrical components must not be accessible to the user after installation.
- Do not touch the appliance with any wet part of the body and do not operate it when barefoot.
- This appliance can be used by children aged from 8 years and above and persons with reduced physical, sensory or mental capabilities or lack of experience and knowledge if they have been given supervision or instruction concerning use of the appliance in a safe way and understand the hazards involved. Children shall not play with the appliance. Cleaning and user maintenance shall not be made by children without supervision.
- All other maintenance services must be carried out by a specialised technician.
- When drilling through the wall pay attention not to damage electric connections and/or pipes.
- Air vents must always discharge to the outside.
- The manufacturer rejects all responsibilities for any damage caused by improper use or wrong settings.
- Appropriate maintenance and cleaning ensure the good working order and the best performance of the appliance. Regularly clean all stubborn surface dirt to avoid grease build up. Remove and clean or change the filter regularly. This must be completed in accordance with the “Cleaning and maintenance” instructions provided.
- Never flame cook food (flambé) under the appliance. Using free flames might cause fire.
- Failure to observe the instructions for cleaning the hood and replacing the filters may result in a fire.
- Exhaust air must not be vented through a flue used for removal of fumes produced by gas combustion appliances or other combustible materials, but must have a separate outlet. All national regulations governing extraction of fumes must be observed.
- There shall be adequate ventilation if the hood is being used at the same time as other appliances using gas or other combustible materials. The negative pressure of the room

must not exceed 4 Pa (4x 10<sup>-5</sup> bars). For this reason ensure that the room is well ventilated. In case of doubts, please consult an authorized service assistance center or similar qualified person.

- Do not leave frying pans unattended when frying, as the frying oil may catch fire.
- Before touching the light bulbs, ensure that they are cold.
- Do not use or leave the hood without the light bulb correctly fitted, as this may cause electric shock.
- The hood is not a work surface, therefore do not place any objects on top of it or overload it.
- During all installation and maintenance operations wear appropriate working gloves.
- This appliance is not suitable for outdoor use.

**⚠ WARNING:** when the hob is in use, accessible parts of the hood may become hot.

### Installation and connection

In the event of problems, contact the Authorized Service Centre. To prevent any damage, only remove the appliance from its packaging at the time of installation.

### Preparing for installation

**⚠ WARNING:** this is a heavy product; the hood should only be lifted and installed by two or more people.

The minimum distance between the hob and the bottom part of the hood must not be less than 65 cm for burning gas or other fuels and 50cm for electric cookers.

Only for Korea, minimum distance must not be less than 65 cm also for electric cookers.

Before installation also check the minimum distances stated in the manual of the cooker.

If the installation instructions for the cooker specify a greater distance between cooker and hood, this distance must be observed.

### Electrical connection

Make sure the power voltage specified on the appliance rating plate is the same as the mains voltage.

This information can be found on the inside of the hood, under the grease filter. Power cable replacement (type H05 VV-F) must be carried out by a qualified electrician. Contact an authorized service centre.

If the hood is fitted with an electric plug, connect the plug to a socket complying with current regulations, located in an accessible place.

**⚠ WARNING:** if no plug is fitted (direct wiring to the mains), or if the socket is not located in an accessible place, a qualified electrician should install a

standardised double pole power switch that will enable complete isolation from the mains in case of category III overvoltage conditions, in accordance with wiring rules.

## Use

The hood has been designed to be installed and used either as a “Extraction installation”, or as a “Recirculation installation”.

**Extraction installation** (see symbol  in installation booklet)

Cooking steam is sucked and channelled outside the house through a discharge duct (not supplied), fitted to the hood steam outlet. Ensure that the discharge duct is correctly fitted to the air outlet, unit using an appropriate connection system.

**Important:** If already installed, remove the charcoal filter/s.

**Recirculation installation**

(see symbol  in installation booklet)

The air is filtered through one or more the charcoal filters, and then resent into room.

**Important:** Ensure appropriate air circulation around the hood.

**Important:** If the hood is supplied without charcoal filters, these must be fitted before the hood can be used. Filters are available in IKEA shops.

The hood should be installed away from particularly dirty areas, windows, doors and heat sources.

The accessories for wall fixing are not included because walls made of different materials require different types of fixing accessories.

Use fixing systems suitable for the walls of your home and the weight of the appliance. For more details, contact a specialized dealer.

Keep this booklet for future consultation.

## Product description

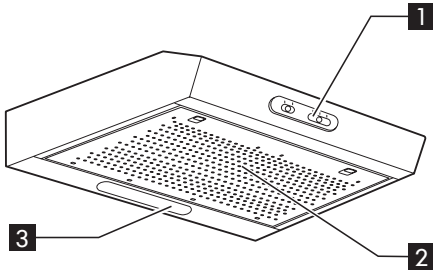

- 1** Control Panel.
- 2** Grease filter.
- 3** Lighting unit.

## Control panel

### A Light button.

The light button has two positions.

To switch on the lights: move the button to the right.

### B Extraction power selection button.

The extraction speed switch has different settings, depending on the amount of steam and fumes.

To increase the extraction power: move the button to the right.

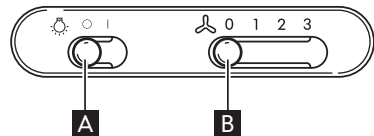

## Cleaning and maintenance

### ⚠ WARNING:

- Never use steam cleaning equipment.
- Disconnect the appliance from the power supply.

**IMPORTANT:** do not use corrosive or abrasive detergents. If any of these products accidentally comes into contact with the appliance, clean immediately with a damp cloth.

- Clean the surfaces with a damp cloth. If it is very dirty, add a few drops of washing up detergent to the water. Finish off with a dry cloth.

**IMPORTANT:** do not use abrasive sponges or metallic scrapers or scourers. Over time, these can ruin the surface.

- Use detergents specifically designed for

cleaning the appliance and follow the manufacturer instructions.

**IMPORTANT:** clean the filters at least monthly to remove any oil or grease residuals.

### To clean the grease filter

The metal grease filter has an unlimited life and must be washed once a month by hand or dishwasher at low temperature and with a short cycle. With cleaning in a dishwasher the grease filter may become dull; this does not effect its filtering capacity.

### Grease filter maintenance:

1. Unplug the appliance or disconnect the power supply.
2. Remove the grease filters: pull the spring release handle, then remove the filter downwards.



3. After cleaning the grease filter, remount in reverse order ensuring the entire extraction surface is covered.

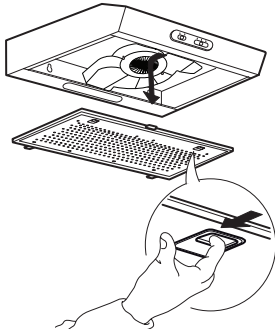

**Charcoal filter maintenance (if the hood is installed in recirculation installation)**

1. Pull out the plug or disconnect the power supply.
2. Remove the grease filter
3. If the carbon filters are already fitted (two filters that cover the protective grilles for the motor impeller) and have to be replaced, turn the central handle anti-clockwise to unlock them.
4. Open the two filter shells
5. Pull out the two circular mats
6. Proceed in reverse order to fit the new filters.
7. Refit the grease filters.

Unlike traditional charcoal filters, this charcoal filter can be washed and reactivated.

**Care and cleaning long life Charcoal filter**

- The anti-odour filter shall be washed and regenerated every 3-4 months (or more frequently if the hood is subject to intensive use), up to a Max. of 8 regeneration cycles (in case of particularly intensive use it is recommended that you do not exceed 5

cycles).

**Regeneration procedure:**

- Wash in the dishwasher at a MAX temperature of 70° or hand wash in hot water without using abrasive sponges (do not use detergents!)
- Dry in the oven at a MAX temperature of 70° for 2 hours or dry at room temperature, standing the filter in a vertical position to facilitate drainage.

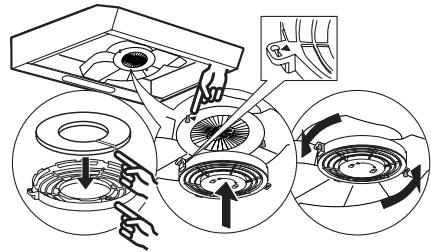

**Lamp maintenance**

1. Disconnect the hood from the power supply.
2. Open the extractor grille or remove the self-supporting grease filter.
3. Replace the damaged lamp. Use E14 3W max LED lamps only.
4. Refit the extractor grille or grease filter.

**IMPORTANT:** make sure you don't touch the lamp with your bare hands.

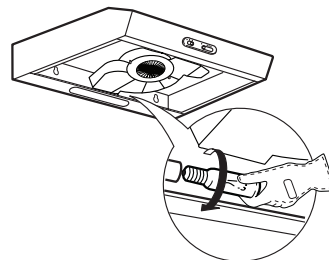

Lamp	Power (W)	Socket	Voltage (V)	LCL	ILCOS D Code
	3	E14	230	55	DRGSB/C/UB-3/27/ 1B-230-E14-55

## What to do if ...

Problem	Possible cause	Solution
The appliance does not work	There is no mains electrical power	Check for the presence of mains electrical power. Turn off the appliance and restart it to see if the faults persists.
	The appliance is not connected to the electrical supply	Check if the appliance is connected to the electrical supply. Turn off the appliance and restart it to see if the faults persists.
The hood's suction level is not enough	The suction speed is too low	Check the suction speed and adjust as necessary.
	The grease filters are dirty <b>2</b>	Check that the filters are clean If not, clean the filters in the dishwasher.
	The anti-odors filters are dirty	Check that the anti-odour filters are properly washed as recommended
	The air vents are obstructed	Check the air vents for any obstructions and remove as necessary.
The light does not work	The LED is broken <b>3</b>	For replacement, contact the Authorized Service Centre.

### Before contacting the Authorized Service Centre:

Switch the appliance on again to see if the problem has disappeared. If not, switch it off again and repeat the operation after an hour. If your appliance still does not work properly after carrying out the checks listed in the troubleshooting guide and switching the appliance on again, contact the Authorized Service Centre, clearly explaining the problem and specifying:

- the type of fault;
- the model;
- the type and serial number of the appliance (given on the rating plate);
- the Service number (the number after the word SERVICE on the rating plate inside the appliance).

**SERVICE** 0000 000 00000



**Technical data**

Type of product		Wall mounted hood	
Dimensions	Width	mm	600
	Depth	mm	510
	Total height in extraction installation version min-max	mm	132
	Total height in recirculation installation version min-max	mm	132
Total power		W	118
Lamps info	Type		LED Bulb
	Number & Power	W	1x3W
	Socket		E14
Installation minimum height - gas hob		mm	650
Installation minimum height - elec hob		mm	500
Installation minimum height - elec hob (VALID ONLY FOR KOREA)		mm	650
Product Weight		Kg	7.2
<b>Additional Product Information compliant to commission regulation (EU) No 66/2014</b>			
Model identifier			LAGAN 105.093.28 LAGAN 305.093.27 LAGAN 705.093.30 LAGAN 905.093.29
Annual Energy Consumption	kWh/a		63.3
Time increase factor			1.7
Fluid Dynamic Efficiency	%		8.1
Energy Efficiency Index			89
Measured air flow rate at best efficiency point	m <sup>3</sup> /h		160
Measured air pressure at best efficiency point	Pa		180
Maximum air flow	m <sup>3</sup> /h		272
Measured electric power input at best efficiency point	W		98.5
Nominal power of the lighting system	W		3
Average illumination of the lighting system on the cooking surface	lux		87
Power consumption in standby mode	W		na
Power consumption off mode	W		na
A-weighted Sound Power Emission at maximum speed	dB(A)		71

The technical information is situated in the rating plate on the internal side of the appliance.

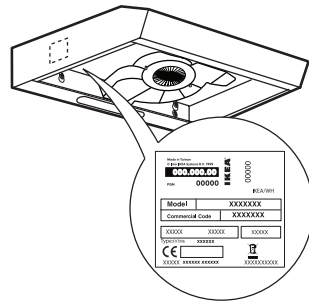

## Environmental concerns

### Maintenance

The symbol  on the product or on its packaging indicates that this product may not be treated as household waste.

Instead it shall be handed over to the applicable collection point for the recycling of electrical and electronic equipment.

By ensuring this product is disposed of correctly, you will help prevent potential negative consequences for the environment and human health, which could otherwise be caused by inappropriate waste handling of this product.

For more detailed information about recycling of this product, please contact your local city office, your household waste disposal service or the shop where you purchased the product.

### Packaging materials

The materials with the symbol  are recyclable. Dispose the packaging in suitable collection containers to recycle it.

## IKEA GUARANTEE

### How long is the IKEA guarantee valid?

This guarantee is valid for two (2) years from the original date of purchase of your appliance at IKEA. The original sales receipt is required as proof of purchase. If service work is carried out under guarantee, this will not extend the guarantee period for the appliance.

### Who will execute the service?

IKEA service provider will provide the service through its own service operations or authorized service partner network.

### What does this guarantee cover?

The guarantee covers faults of the appliance, which have been caused by faulty construction or material faults from the date of purchase from IKEA. This guarantee applies to domestic use only. The exceptions are specified under the headline "What is not covered under this guarantee?" Within the guarantee period, the costs to remedy the fault e.g. repairs, parts, labour and travel will be covered, provided that the appliance is accessible for repair without special expenditure. On these conditions the respective local regulations are applicable. Replaced parts become the property of IKEA.

### What will IKEA do to correct the problem?

IKEA appointed Service Provider will examine the product and decide, at its sole discretion, if it is covered under this guarantee. If considered covered, IKEA Service Provider or its authorized service partner through its own service operations, will then, at its sole discretion, either repair the defective product or replace it with the same or a comparable product.

### What is not covered under this guarantee?

- Normal wear and tear.
- Deliberate or negligent damage, damage

caused by failure to observe operating instructions, incorrect installation or by connection to the wrong voltage, damage caused by chemical or electro-chemical reaction, rust, corrosion or water damage including but not limited to damage caused by excessive lime in the water supply, damage caused by abnormal environmental conditions.

- Consumable parts including batteries and lamps.
- Non-functional and decorative parts which do not affect normal use of the appliance, including any scratches and possible color differences.
- Accidental damage caused by foreign objects or substances and cleaning or unblocking of filters, drainage systems or soap drawers.
- Damage to the following parts: ceramic glass, accessories, crockery and cutlery baskets, feed and drainage pipes, seals, lamps and lamp covers, screens, knobs, casings and parts of casings. Unless such damages can be proved to have been caused by production faults.
- Cases where no fault could be found during a technician's visit.
- Repairs not carried out by our appointed service providers and/or an authorized service contractual partner or where non-original parts have been used.
- Repairs caused by installation which is faulty or not according to specification.
- The use of the appliance in a non-domestic environment i.e. professional use.
- Transportation damages. If a customer transports the product to his home or another address, IKEA is not liable for any damage that may occur during transport. However, if IKEA delivers the product to the customer's delivery address, then damage to the product that occurs during this delivery will be covered by IKEA.

- Cost for carrying out the initial installation of the IKEA appliance.
- However, if an IKEA appointed Service Provider or its authorized service partner repairs or replaces the appliance under the terms of this guarantee, the appointed Service Provider or its authorized service partner will reinstall the repaired appliance or install the replacement, if necessary.
- All plumbing and electrical installation, are not the responsibility of IKEA, and customer must complete these work before the execution work.

### How country law applies

The IKEA guarantee gives you specific legal rights, which cover or exceed all the local legal demands. However these conditions donot limit in any way consumer rights described in the local legislation.

**Valid for INDIA only:** The courts at New Delhi have exclusive jurisdiction for setting the claims or disputes or matters arising outof present Warranty.

### Area of validity

This warranty is valid only in the country where the product has been purchased; the services will be provided in the framework ofthe guarantee conditions. An obligation to carry out services in the framework of the guarantee exists only if the appliance complies and is installed in accordance with:

- the technical specifications of the country in which the guarantee claim is made;
- the Assembly Instructions and User Manual Safety Information;

### The dedicated AFTER SALES for IKEA appliances

Please don't hesitate to contact IKEA appointed Authorized Service Centre to:

- make a service request under this guarantee;
- ask for clarifications on installation of the

IKEA appliance in the dedicated IKEA kitchen furniture;

- ask for clarification on functions of IKEA appliances.

To ensure that we provide you with the bestassistance, please read carefully the Assembly Instructions and/or the User Manual before contacting us.

### How to reach us if you need our service



The IKEA after sales customer service center will assist you on thephone with basic trouble-shooting for your appliances at the time of service call request. Please refer to

**www.IKEA.com**

and select your local store for local store phone numbers and opening times.

**i** In order to provide you a quicker service, we recommend to use the specific phone numbers listed on this manual. Always refer to the numbers listed in the booklet of the specific appliance you need an assistance for. Please also always refer to the IKEA article number (8 digit code) and 12 digit service number placed on the rating plate of your appliance.

**i** **SAVE THE SALES RECEIPT!**

It is your proof of purchase and required for the guarantee to apply. Note that the receipt reports also the IKEA article name and number (8 digit code) for each of the appliances youhave purchased.

### Do you need extra help?

For any additional questions not related to After Sales of your appliances please contactyour nearest IKEA store call centre. We recommend you read the appliance documentation carefully before contacting us.



