

METALLISK

Design Mikael Axelsson



Design and Quality
IKEA of Sweden

ENGLISH	4
DEUTSCH	8
FRANÇAIS	12
NEDERLANDS	16
DANSK	20
ÍSLENSKA	24
NORSK	28
SUOMI	32
SVENSKA	36
ČESKY	40
ESPAÑOL	44
ITALIANO	48
MAGYAR	52
POLSKI	56
EESTI	60
LATVIEŠU	64
LIETUVIŲ	68
PORTUGUES	72
ROMÂNA	76
SLOVENSKY	80

БЪЛГАРСКИ	84
HRVATSKI	88
ΕΛΛΗΝΙΚΑ	92
РУССКИЙ	96
УКРАЇНСЬКА	100
SRPSKI	104
SLOVENŠČINA	108
TÜRKÇE	112
中文	116
繁中	120
한국어	124
日本語	128
BAHASA INDONESIA	132
BAHASA MALAYSIA	136
عربي	140
ไทย	144

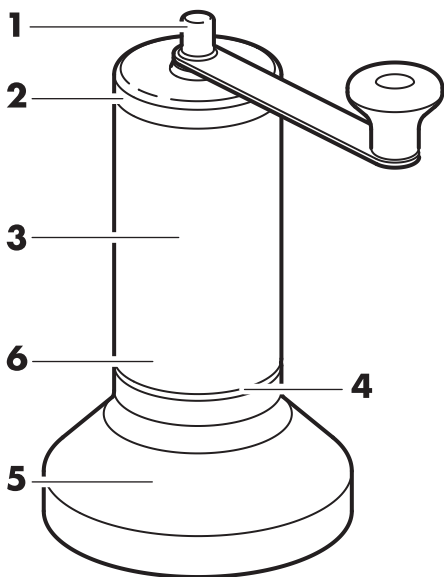
**Illustration**

1. Handle
2. Lid
3. Grinder
4. Adjustment wheel
5. Base/Collector
6. Ceramic grinding cone

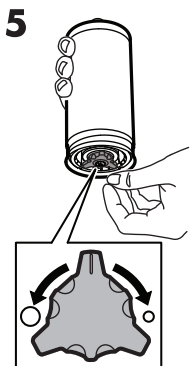
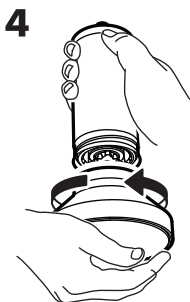
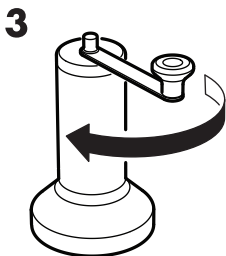
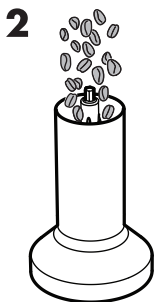
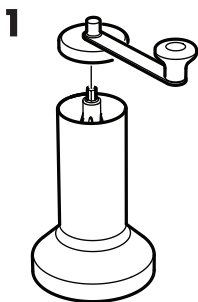

How to use

Pour whole coffee beans into the grinder (3).

Grind the coffee beans. You can adjust the coarseness by turning the adjustment wheel.

Detach the base/collector and pour the ground coffee beans into the coffee-maker.

Fix the base/collector back onto the grinder.

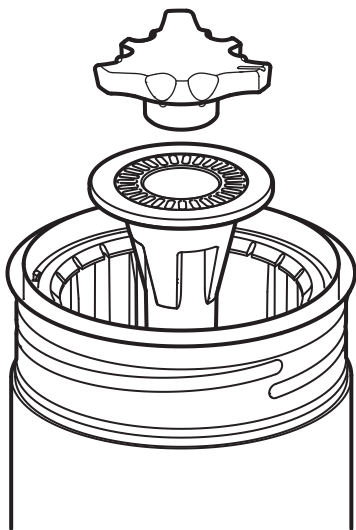

Cleaning

Unscrew the adjustment wheel (counter-clockwise) and remove the ceramic grinding cone.

Clean the ceramic grinding cone in hot water.

Screw back the adjustment wheel (clockwise) onto the grinder.

Make yourself a cup of coffee.

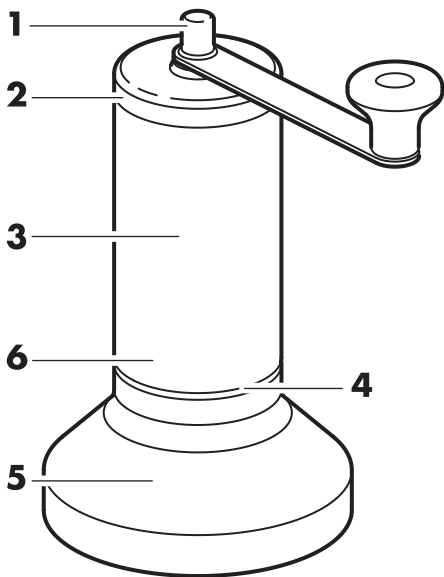

Bildtext

1. Griff
2. Deckel
3. Mühle
4. Einstellrad
5. Sockel/Auffangbehälter
6. keramisches Mahlwerk

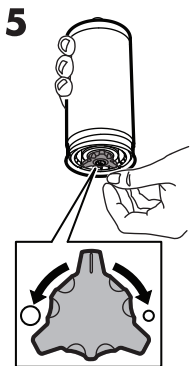
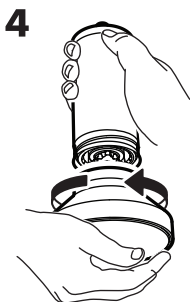
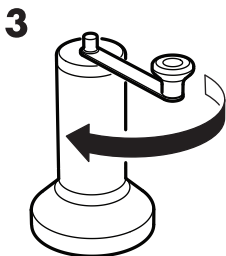
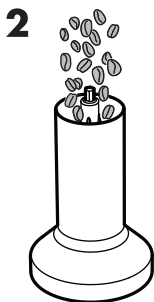
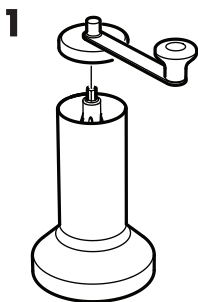

Benutzung

Kaffeebohnen in die Mühle (3) geben.

Die Kaffeebohnen mahlen. Der Mahlgrad lässt sich durch Drehen am Einstellrad justieren.

Den Sockel/Auffangbehälter abnehmen und die gemahlene Bohne in einen Kaffeebereiter geben.

Sockel/Auffangbehälter wieder auf die Kaffeemühle aufsetzen.

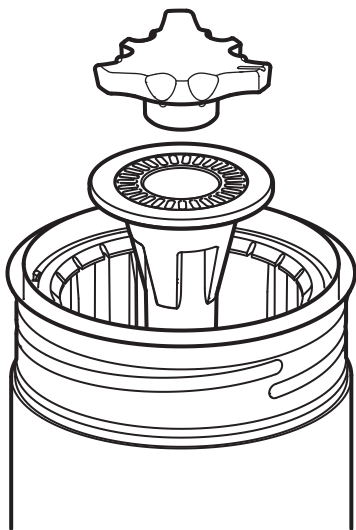

Reinigung

Das Einstellrad abschrauben (entgegen dem Uhrzeigersinn) und das keramische Mahlwerk herausnehmen.

Das Mahlwerk mit heißem Wasser säubern.

Das Einstellrad (im Uhrzeigersinn) in die Mühle einschrauben.

Lass dir deinen Kaffee schmecken!

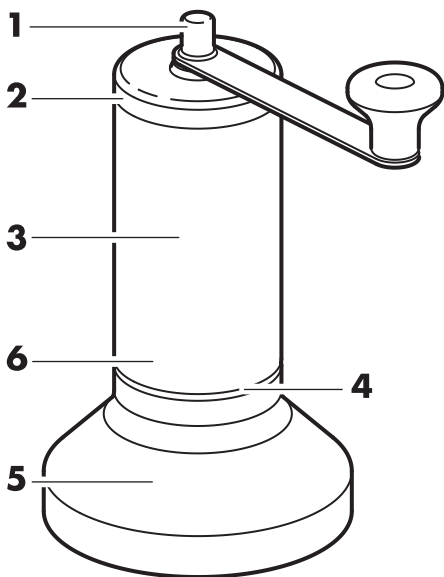
**Illustration**

1. Poignée
2. Couvercle
3. Broyeur
4. Molette de réglage
5. Réservoir/Collecteur
6. Mécanisme de broyage en céramique

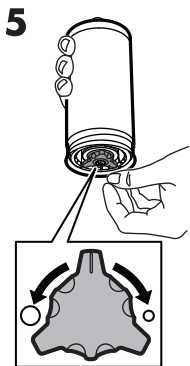
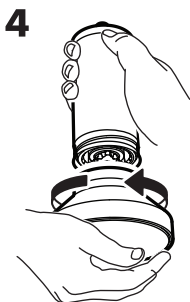
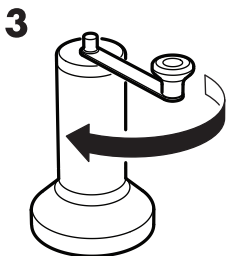
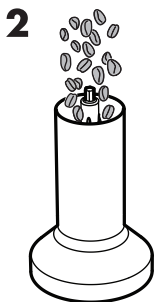
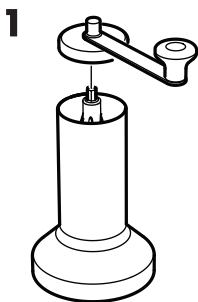

Mode d'emploi

Placer les grains de café sur le broyeur (3).

Moudre les grains de café. Vous pouvez ajuster le degré de mouture en tournant la molette de réglage.

Retirer le socle/réservoir et verser les grains de café moulus dans votre cafetière.

Remettre le socle/réservoir en place.

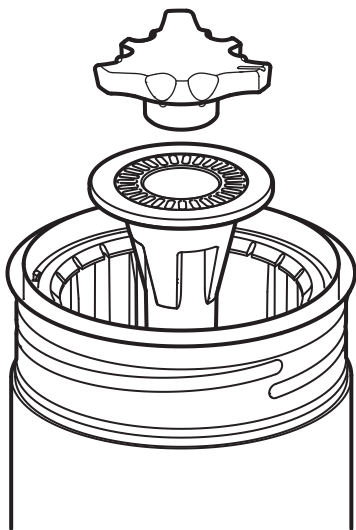

Entretien

Dévisser la molette de réglage (dans le sens inverse des aiguilles d'une montre) et retirer le mécanisme de broyage en céramique.

Nettoyer le mécanisme de broyage en céramique à l'eau chaude.

Revisser la molette de réglage (dans le sens des aiguilles d'une montre) sur le broyeur.

Préparez-vous une bonne tasse de café.

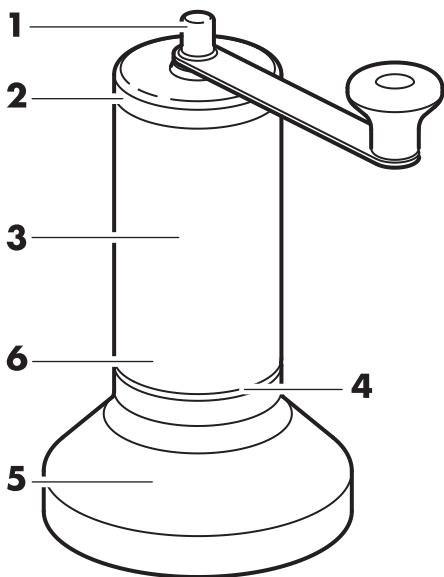

Illustratie

1. Hendel
2. Deksel
3. Molen
4. Instelwiel
5. Voet/verzamelaar
6. Keramische conische maalschijven

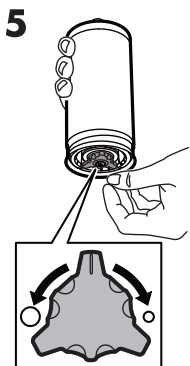
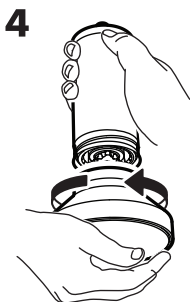
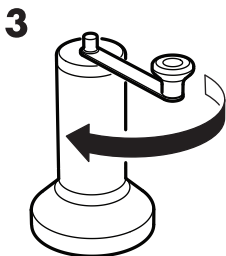
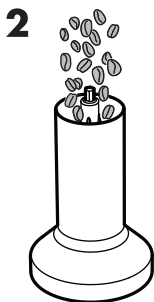
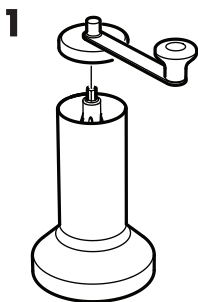

Gebruiksaanwijzing

Vul de molen met hele koffiebonen (3).

Maal de koffiebonen. Je kan de grofheid aanpassen door aan het instelwiel te draaien.

Maak de voet/verzamelaar los en doe de gemalen koffiebonen in het koffiezetapparaat.

Zet de basis/verzamelaar terug op de molen.

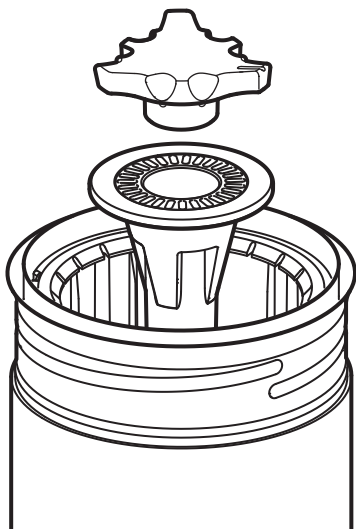
**Onderhoudsvoorschrift**

Draai het instelwiel (tegen de klok in) los en verwijder de keramische conische maalschijven.

Maak de keramische conische maalschijven schoon in heet water.

Draai het instelwiel weer (met de klok mee) terug op de molen.

Maak een lekkere kop koffie voor jezelf.

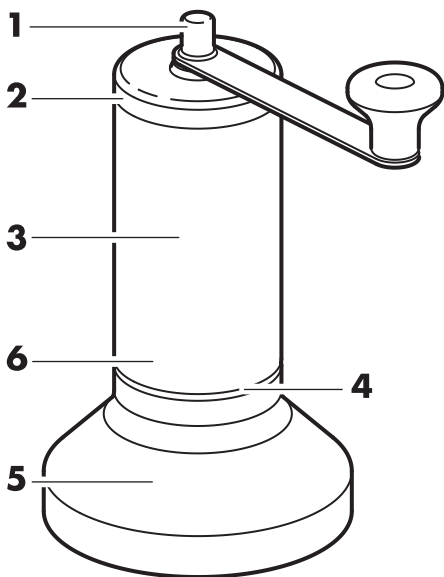
**Illustration**

1. Håndtag
2. Låg
3. Kværn
4. Indstillingshjul
5. Fod/opsamler
6. Konisk keramikkværn

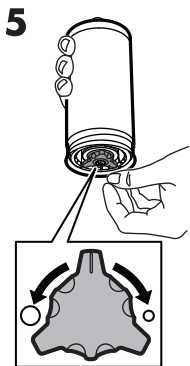
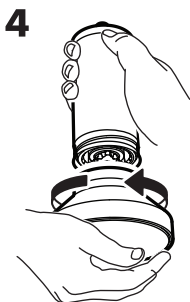
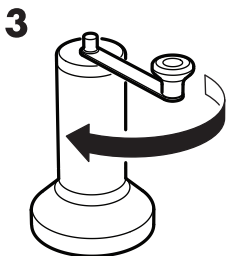
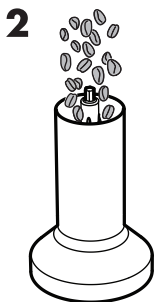
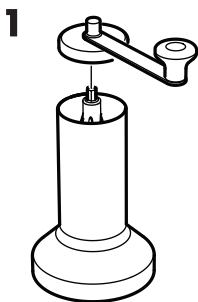

Brugsanvisning

Hæld kaffebønner i kværnen (3).

Kværn kaffebønnerne. Du kan tilpasse bønnernes finhedsgrad ved at dreje på indstillingshjulet.

Afmonter foden/opsamleren, og hæld kaffebønnerne i en kaffekande.

Monter atter foden/opsamleren på kværnen.

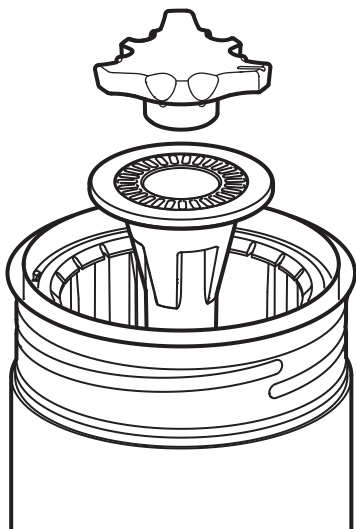

Rengøring

Skru indstillingshjulet af (mod uret), og fjern den koniske keramikkværn.

Rengør kværnen i varmt vand.

Skru indstillingshjulet (med uret) på kværnen.

Lav dig en kop kaffe.

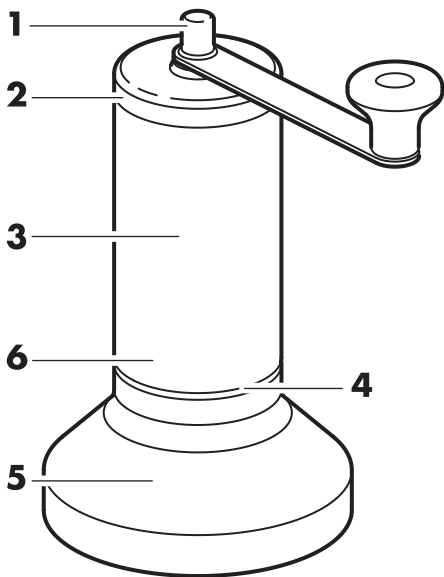

Skýringarmynd

1. Sveif
2. Lok
3. Kvörn
4. Tannhjól til að stillingar
5. Ílát fyrir malað kaffi
6. Keramikspíss í kvörn

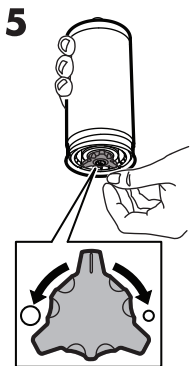
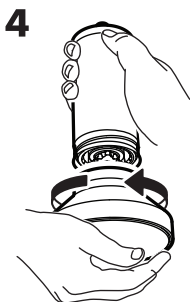
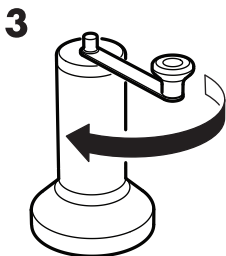
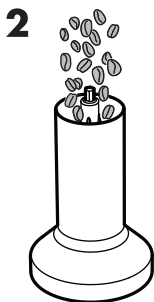
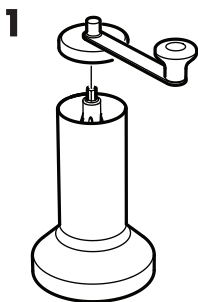

Notkunarleiðbeiningar

Helltu kaffibaunum í kaffikvörnina (3).

Malaðu kaffibaunirnar. Þú getur stillt grófleikann með tannhjólinu.

Losaðu ílátið og helltu malaða kaffinu í kaffikönnuna.

Settu ílátið aftur á sinn stað.

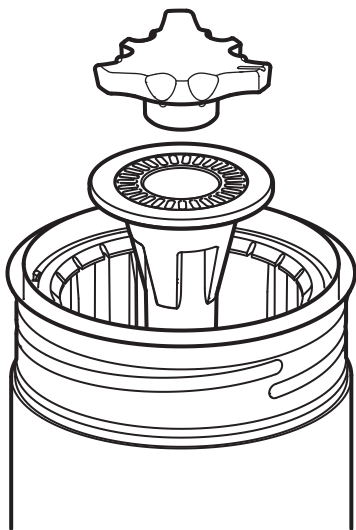
**Þrif**

Skrúfaðu tannhjólíð í sundur (rangsælis) og fjarlægðu kvörnina.

Þrífðu kvörnina í heitu vatni.

Skrúfaðu tannhjólíð aftur á (réttisælis) kaffikvörnina.

Nú getur þú hellt upp á kaffi.

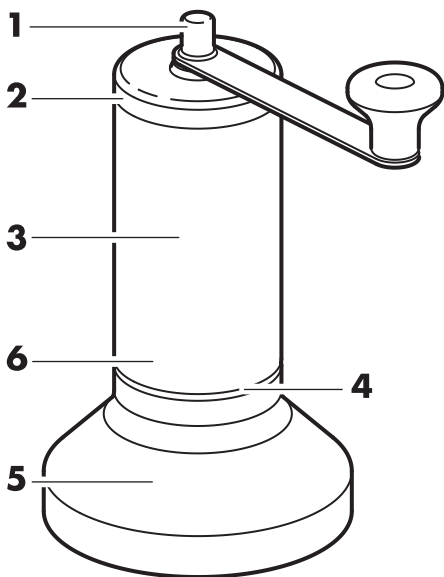
**Illustrasjon**

1. Håndtak
2. Lokk
3. Kvern
4. Innstillingshjul
5. Bunn/oppsamler
6. Keramisk kvernverk

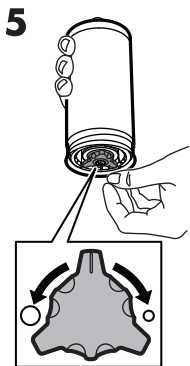
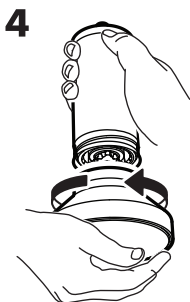
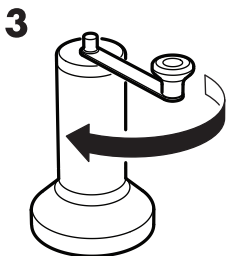
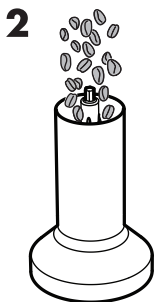
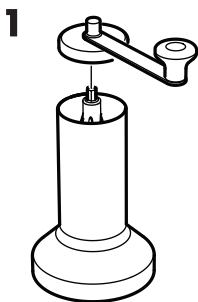

Slik gjør du

Hell i hele kaffebønner i kverna (3).

Mal kaffebønnene. Du kan justere grovheten ved å vri på innstillingshjulet.

Løsne bunnen/opsamleren og hell de malte kaffebønnene oppi kaffemaskinen.

Sett bunnen/opsamleren tilbake på kverna.

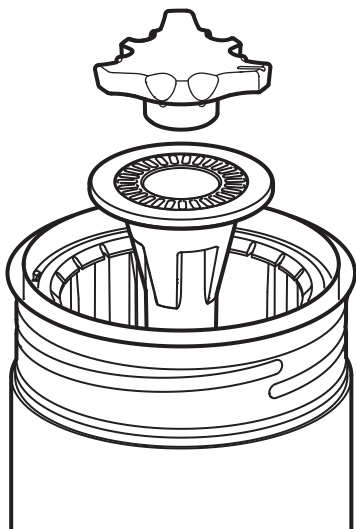

Rengjøring

Skru løs innstillingshjulet (mot klokka) og ta av det keramiske kvernverket.

Rengjør det keramiske kvernverket i varmt vann.

Skru innstillingshjulet (med klokka) på kverna igjen.

Lag deg en velfortjent kopp kaffe.

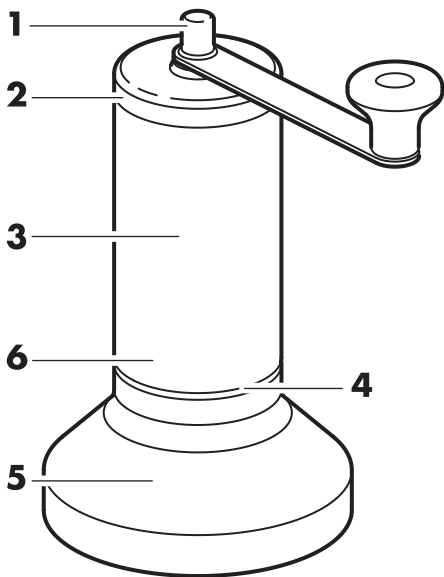
**Kuva**

1. Kahva
2. Kansi
3. Jauhatusosa
4. Säätypyörä
5. Säiliö
6. Keraaminen jauhinmekanismi

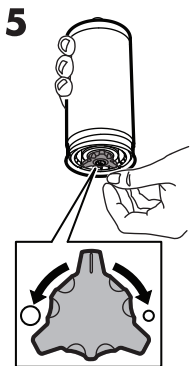
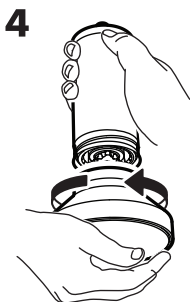
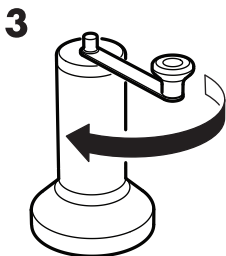
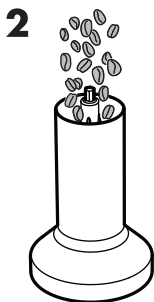
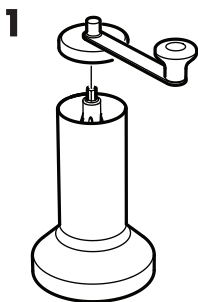

Näin käytät kahvimyllyä

Kaada kokonaisia kahvinpapuja kahvimyllyyn (3).

Jauha pavut. Voit säätää karkeusastetta säätöpyörästä kääntämällä.

Irrota säiliö ja kaada jauhetut pavut kahvinkeittimeen.

Laita säiliö takaisin kahvimyllyyn.

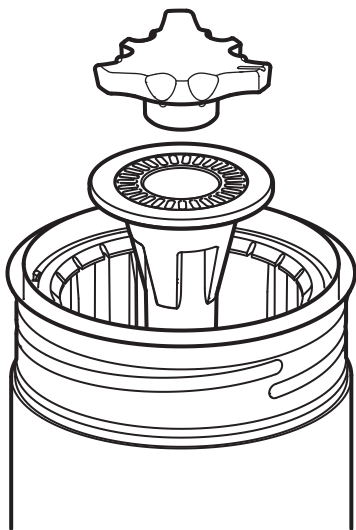

Puhdistus

Käännä säätöpyörää vastapäivään ja irrota keraaminen jauhinmekanismi.

Puhdista mekanismi kuumalla vedellä.

Käännä säätöpyörää myötäpäivään kiinnittääksesi sen takaisin myllyyn.

Nauti kuppi herkullista kahvia.

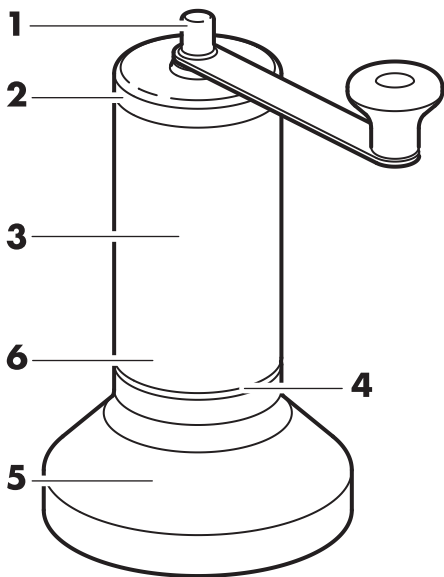
**Illustration**

1. Handtag
2. Lock
3. Kvarn
4. Inställningsratt
5. Bas/Uppsamlare
6. Keramiskt malverk

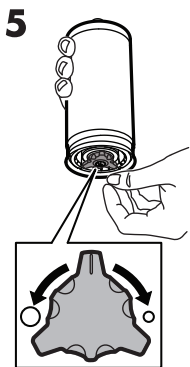
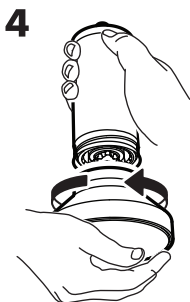
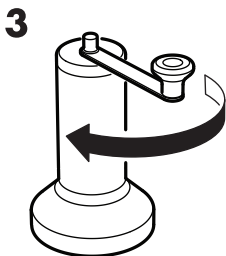
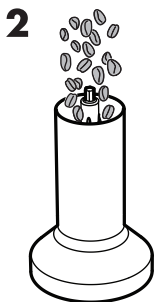
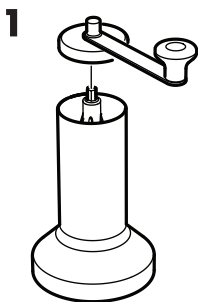

Användning

Häll hela kaffeböner i kvarnen (3).

Mal kaffebönorna. Du kan ställa in grovleken genom att vrida på inställningsratten.

Ta bort basen/upsamlaren och häll de malda kaffebönorna i kaffebyggaren.

Sätt tillbaka basen/upsamlaren på kvarnen.

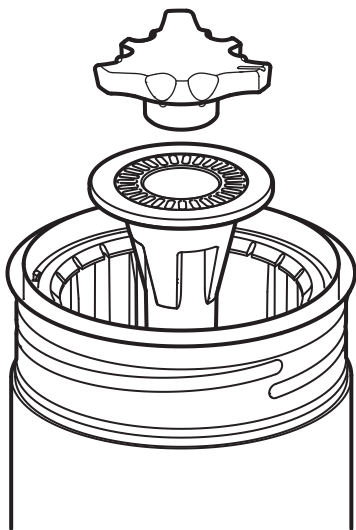

Rengöring

Skruva loss inställningsratten (moturs) och ta ur det keramiska malverket.

Rengör malverket i hett vatten.

Skruva tillbaka inställningsratten (medurs) på kvarnen.

Gör dig själv en kopp kaffe.

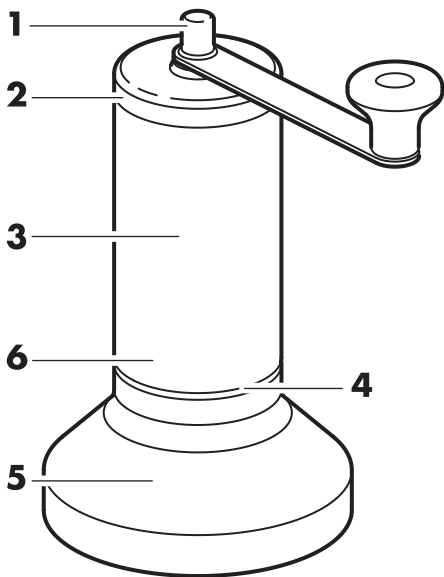

Ilustrace

1. Klička
2. Víčko
3. Mlýnek
4. Nastavovací kolečko
5. Spodní nádobka
6. Keramické mlecí kameny

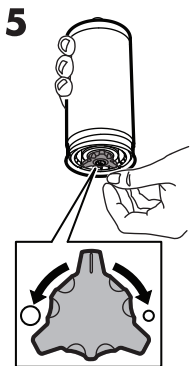
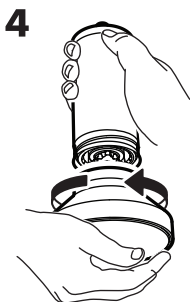
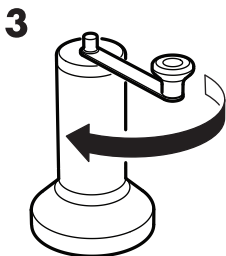
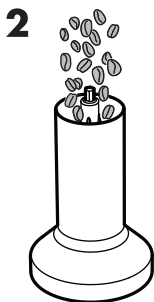
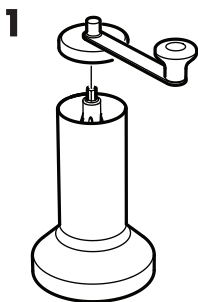

Návod k použití

Nasypte do mlýnku celá kávová zrna (3).

Rozemelte kávová zrna. Hrubost mletí můžete nastavit pootočením kolečka.

Odpojte nádobku na mletou kávu a nasypte rozemletá zrna do kávovaru.

Připevněte nádobku na mletou kávu zpět k mlýnku.

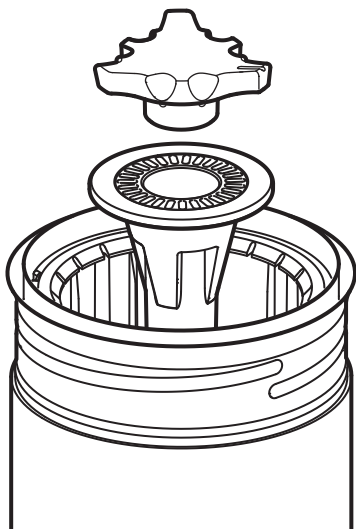

Čištění

Odšroubujte nastavovací kolečko (proti směru hodinových ručiček) a odstraňte keramický mlecí kámen.

Keramický mlecí kámen oplachujte v horké vodě.

Našroubujte nastavovací kolečko (po směru hodinových ručiček) na mlýnek..

Připravte si šálek kávy.

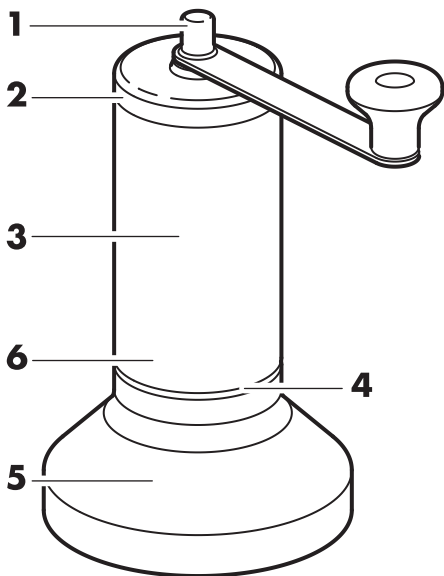

Ilustración

1. Empuñadura
2. Tapa
3. Triturador
4. Engranaje de regulación
5. Base/receptor
6. Mecanismo de trituración de cerámica

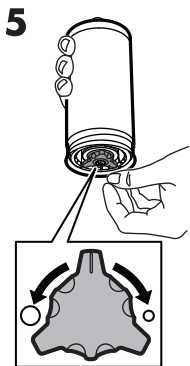
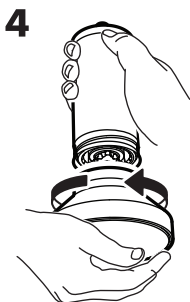
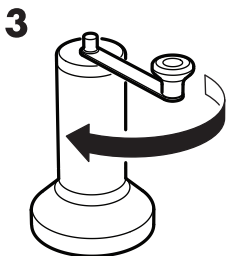
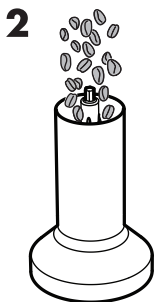
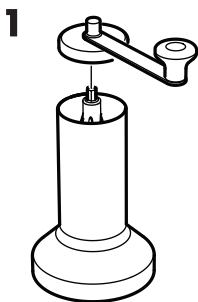

Cómo se utiliza

Vierte los granos en el triturador (3).

Muele los granos de café. Puedes regular el grado de molienda girando el engranaje.

Retira la base/recipiente y vierte el café molido en la cafetera.

Vuelve a colocar la base/recipiente en el molinillo.

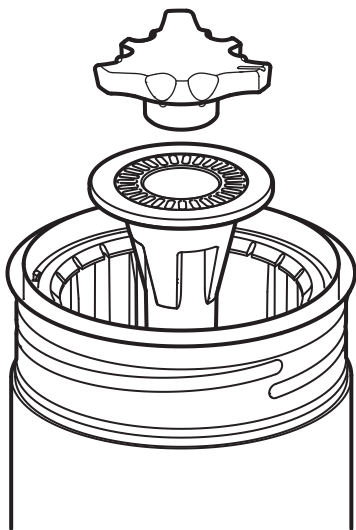

Limpieza

Desenrosca el engranaje de regulación (en el sentido inverso a las agujas del reloj) y retira el mecanismo de trituración de cerámica.

Lava el mecanismo de trituración de cerámica con agua caliente.

Enrosca de nuevo el engranaje de regulación (en el sentido de las agujas del reloj) en el molinillo.

Prepárate una buena taza de café.

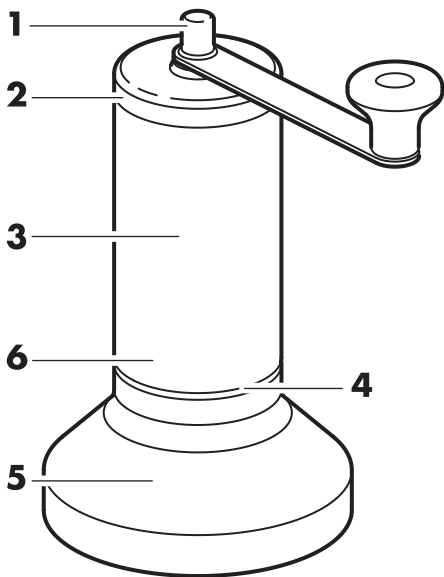
**Figura**

1. Manico
2. Coperchio
3. Macinacaffè
4. Ingranaggio di regolazione
5. Base/serbatoio
6. Cono di macinazione in ceramica

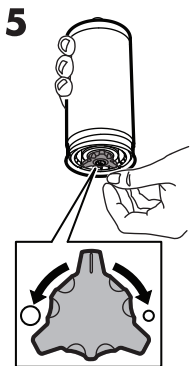
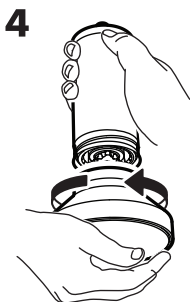
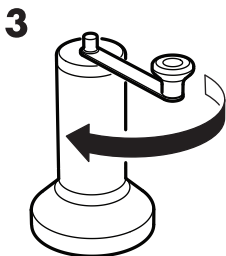
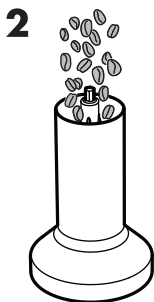
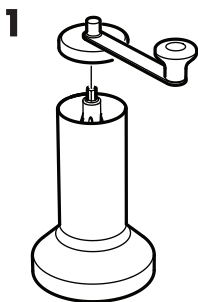

Istruzioni per l'uso

Versa i chicchi interi nel macinacaffè (3).

Macina il caffè. Puoi regolarne la finezza ruotando l'ingranaggio.

Rimuovi la base/serbatoio e versa il caffè macinato nella caffettiera.

Rimonta la base/serbatoio sul macinacaffè.

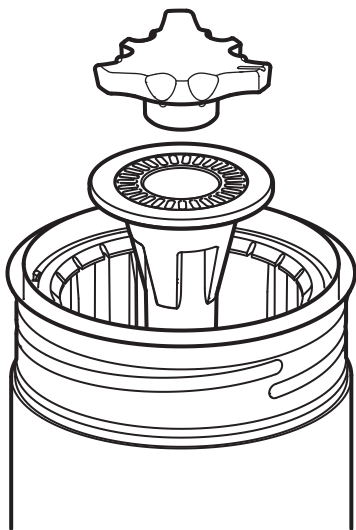
**Pulizia**

Svita l'ingranaggio di regolazione (in senso antiorario) e rimuovi il cono di macinazione in ceramica.

Lava il cono di macinazione in ceramica con acqua calda.

Riavvita l'ingranaggio di regolazione (in senso orario) sul macinacaffè.

Ora puoi prepararti una tazza di caffè.

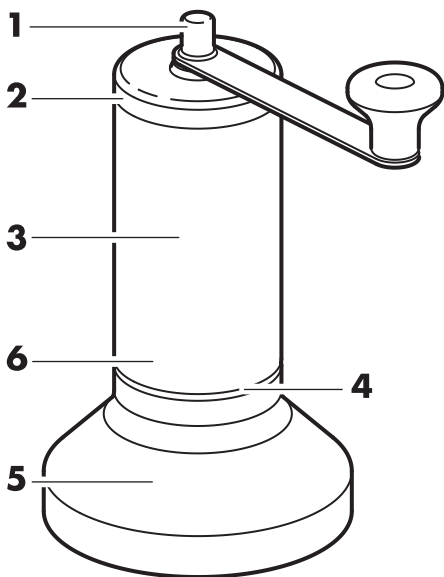
**Illusztráció**

1. Fogantyú
2. Tető
3. Daráló
4. Szabályozó kerék
5. Alap/Gyűjtő
6. Kerámia darálótölcser

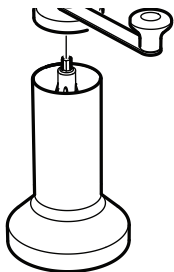

3

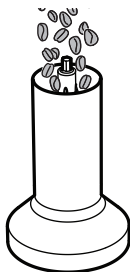

4

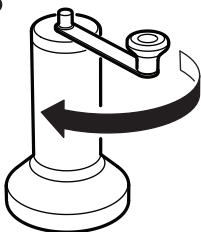

5

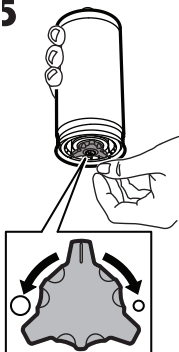

Használati útmutató

Helyezz szemes kávé a darálóba (3).

Daráld meg a kávészemek. Az őrlés finomságát a szabályozó kerékkel módosíthatod.

Távolítsd el az alapot/gyűjtőt és öntsd az őrlött kávé a kávéfőzőbe.

Tedd vissza az alapot/gyűjtőt a darálóra.

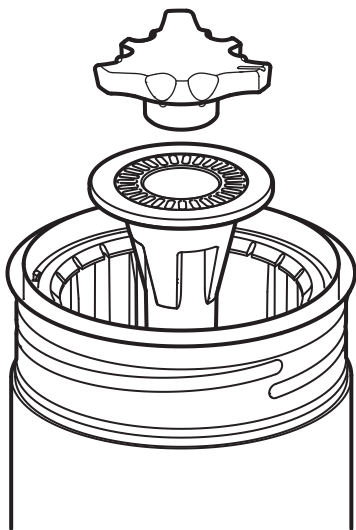

Tisztítás

Csavarod le a szabályozó kereket (óramutató járásával egy irányban) és távolítsd el a kerámia darálótölcserét.

Tisztítsd meg a tölcserét meleg vízzel.

Csavarod vissza a szabályozó kereket (óramutató járásával egy irányban) a darálóra.

Készítsd magadnak egy csésze kávé!

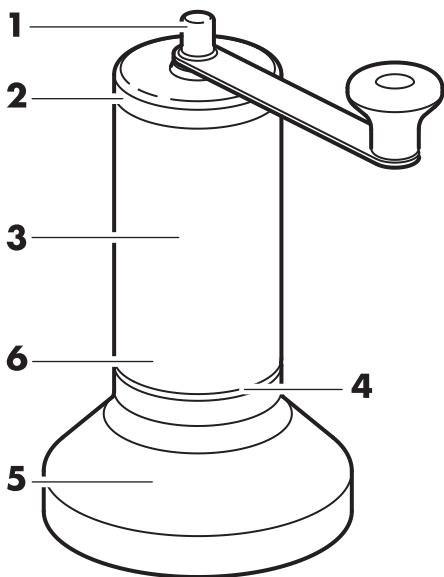
**Ilustracja**

1. Uchwyt
2. Pokrywa
3. Młynek
4. Pokrętło regulacji
5. Podstawa/Pojemnik
6. Ceramiczny stożek

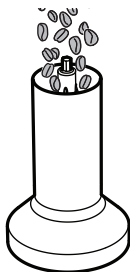
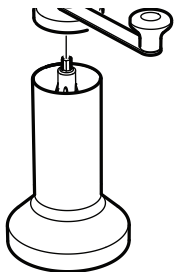

3

4

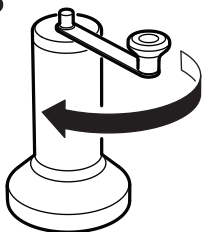

5

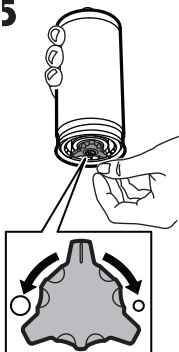

Instrukcja użycia

Wsyp ziarna kawy do młynka (3).

Zmiel ziarna kawy. Można ustawić grubość mielenia ustawiając pokrętko regulacji.

Odłącz podstawę/pojemnik i wsyp zmieloną kawę do ekspresu do kawy.

Zamocuj podstawę/pojemnik ponownie na młynku.

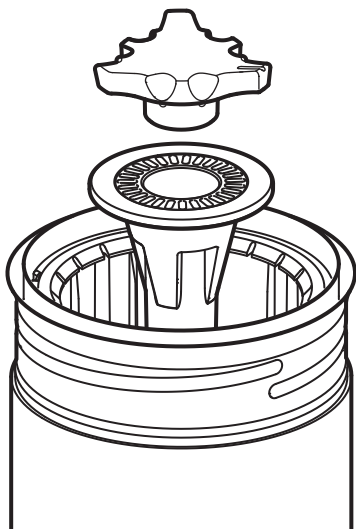

Czyszczenie

Odkręć pokrętko regulacji (w kierunku przeciwnym do wskazówek zegara) i wyjmij ceramiczny stożek mielący.

Wyczyść ceramiczny stożek mielący w ciepłej wodzie.

Przykręć ponownie pokrętko regulacji (zgodnie ze wskazówkami zegara) do młynka.

Przygotuj sobie filiżankę kawy.

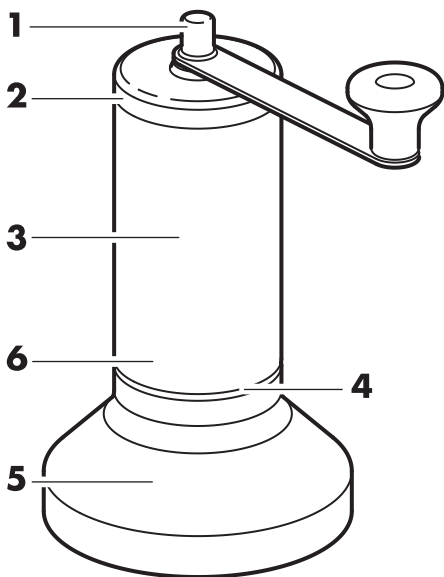
**Illustratsioon**

1. Käepide
2. Kaas
3. Jahvataja
4. Reguleerimisratas
5. Alus/koguja
6. Keraamiline jahvatuskoonus

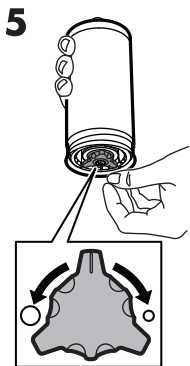
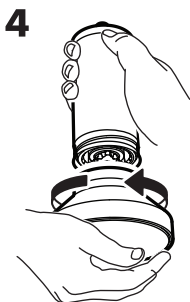
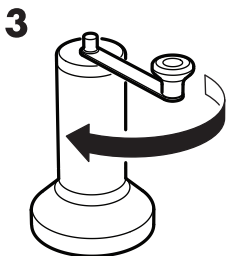
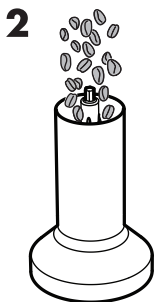
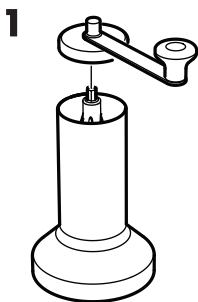

Kasutamine

Vala terved kohvioad kohviveskisse (3).

Jahvata kohvioad. Saad reguleerida ubade jämedust, keerates reguleerimisratast.

Eemalda alus/koguja ja vala jahvatatud kohv kohvimasinasse.

Kinnita alus/koguja tagasi jahvataja külge.

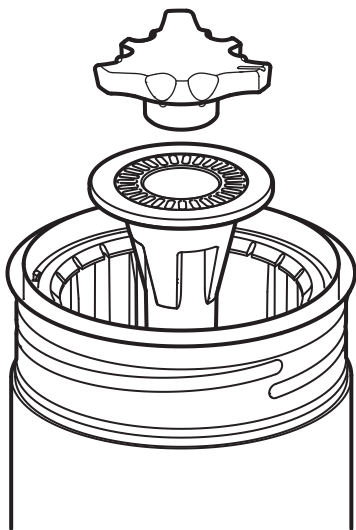

Puhastamine

Kruvi reguleerimisratas lahti (vastupäeva) ja eemalda keraamiline jahvatamiskoonus.

Puhasta keraamilist koonust kuuma veega.

Kruvi reguleerimisratas tagasi (päripäeva).

Tee endale tass kohvi.

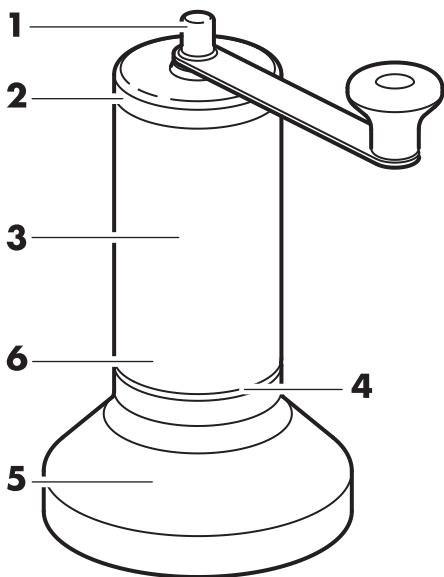
**Attēls**

1. Rokturis
2. Vāciņš
3. Maltuve
4. Regulators
5. Pamatne/Tvertne
6. Keramikas malšanas mehānisms

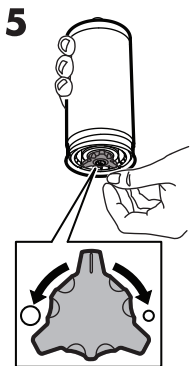
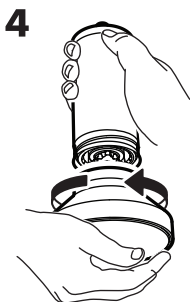
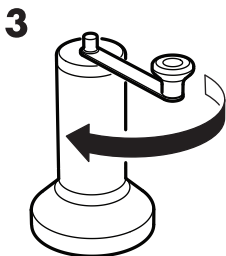
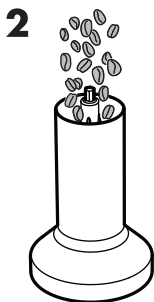
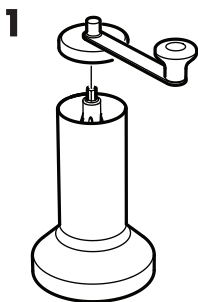

Lietošanas instrukcija

Ieber maltuvē (3) veselas kafijas pupiņas.

Samal kafijas pupiņas. Izmanto regulatoru, lai iegūtu smalkāka vai rupjāka maluma kafiju.

Noņem pamatni/tvertni un ieber samaltās kafijas pupiņas kafijas pagatavošanas ierīcē.

Piestiprini pamatni/tvertni dzirnaviņām.

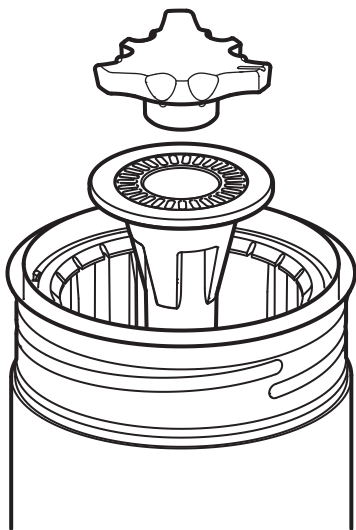

Tīrīšana

Noskrūvē regulatoru no dzirnaviņām, pagriežot to pretēji pulksteņrādītāja virzienam, un noņem keramikas malšanas mehānismu.

Nomazgā keramikas malšanas mehānismu karstā ūdenī.

Pieskrūvē regulatoru dzirnaviņām, pagriežot to pulksteņrādītāja virzienā.

Pagatavo sev tasi kafijas.

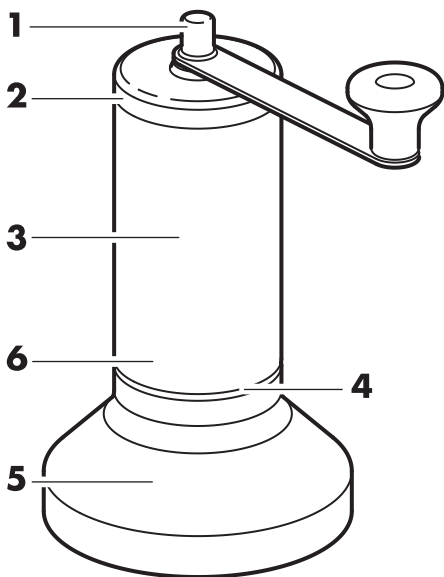
**Iliustracija**

1. Rankena
2. Dangtelis
3. Malūnėlis
4. Regulatorius
5. Pagrindas / talpykla
6. Keraminis malimo mechanizmas

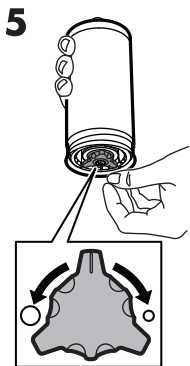
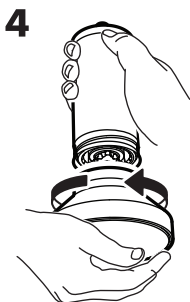
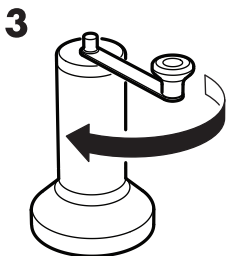
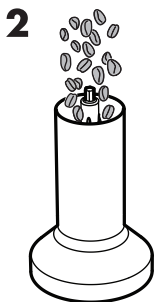
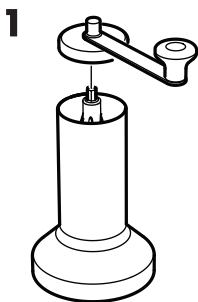

Naudojimas

Į malūnėlį įpilkite kavos pupelių (3).

Sumalkite pupeles. Rupumą galite pasirinkti sukdami reguliatorių.

Nuimkite talpyklą ir išberkite sumaltą kavą į kavavirę.

Pritvirtinkite talpyklą prie kavamalės.

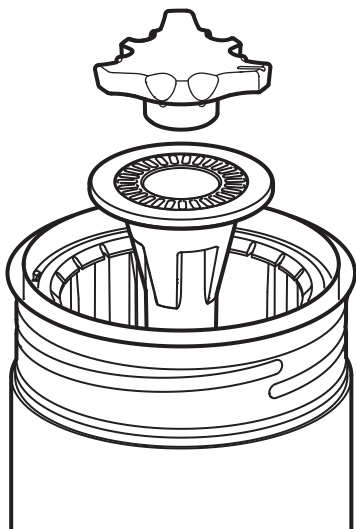
**Priežiūra**

Atsukite reguliatorių (sukite jį prieš laikrodžio rodyklę) ir išimkite keraminį malimo mechanizmą.

Nuplaukite malimo mechanizmą karštu vandeniu.

Įstatykite malimo mechanizmą į vietą ir prisukite atgal reguliatorių.

Išsivirkite puodelį kavos.

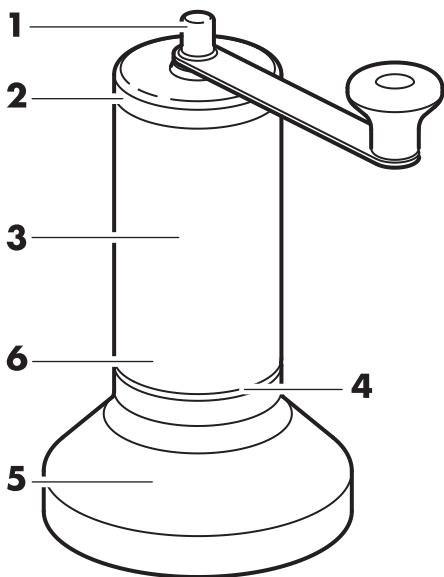

Ilustração

- 1. Pega
- 2. Tampa
- 3. Moinho
- 4. Regulador
- 5. Base/Depósito
- 6. Cone de moagem em cerâmica

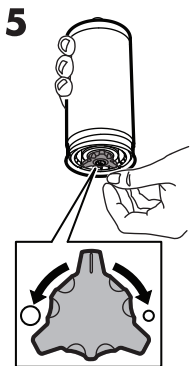
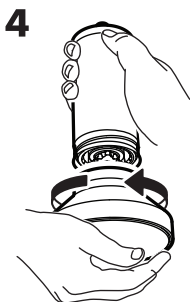
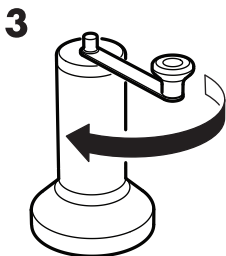
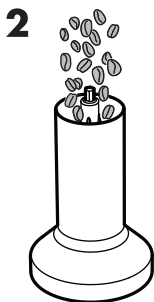
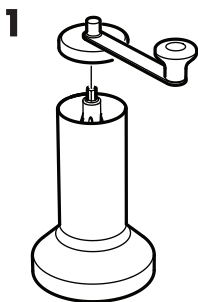

Como utilizar

Deite os grãos de café inteiros no moinho (3).

Para moer os grãos de café, pode escolher o tipo de moagem ajustando o regulador.

Retire a base/depósito e deite o café moído na cafeteira.

Volte a fixar a base/depósito no moinho.

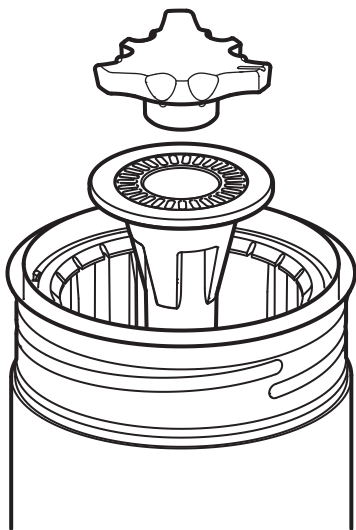

Limpeza

Desenrosque o regulador (em sentido inverso ao dos ponteiros do relógio) e retire o cone de moagem em cerâmica.

Lave o cone de moagem em cerâmica com água quente.

Volte a enroscar o regulador (no sentido dos ponteiros do relógio) no moinho.

Faça uma chávena de café e desfrute.

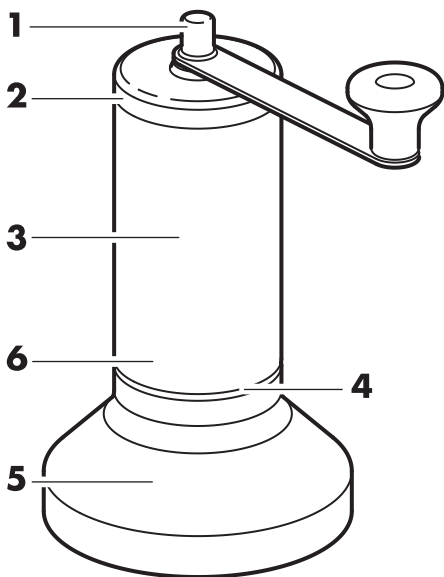
**Ilustrație**

1. Mâner
2. Capac
3. Râșniță
4. Rotiță de reglare
5. Baza/Recipient de colectare
6. Con ceramic de măcinat

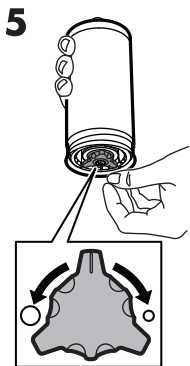
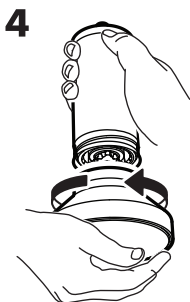
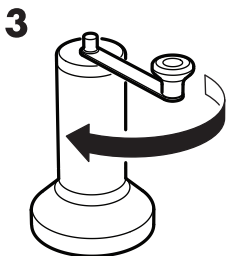
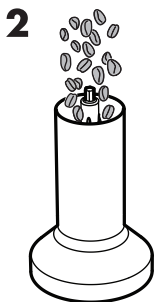
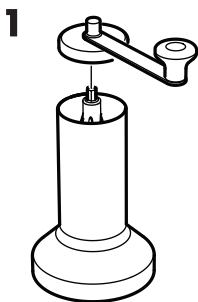

Mod de utilizare

Toarnă boabele de cafea în râșniță (3).

Macină boabele de cafea. Poți regla gradul de măcinare al cafelei răsucind roțița de reglare.

Scoate baza/recipientul de colectare și toarnă cafeaua măcinată în cafetieră.

Fixează baza/recipientul de colectare înapoi în râșniță.

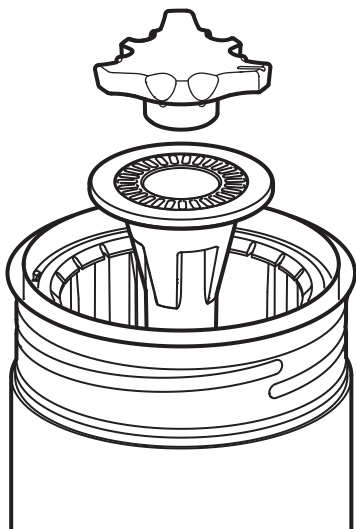

Curățare

Deșurubează roțița de reglare (în sens invers acelor de ceasornic) și scoate conul ceramic de măcinare.

Curăță conul ceramic de măcinare în apă caldă.

Înșurubează roțița de reglare la loc (în sensul acelor de ceasornic) în râșniță.

Acum poți prepara o ceașcă de cafea.

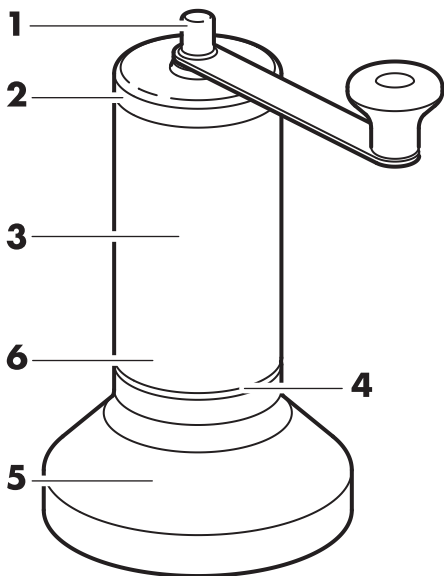
**Ilustrácie**

1. Úchytka
2. Vrchnák
3. Mlynček
4. Nastavovacie koliesko
5. Nádoba na pomletú kávu
6. Keramický kužeľ na mletie

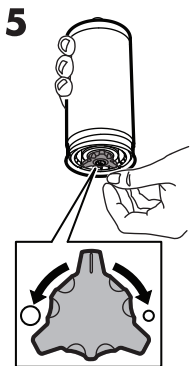
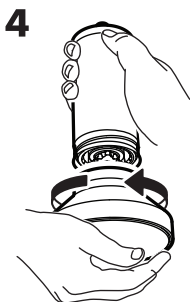
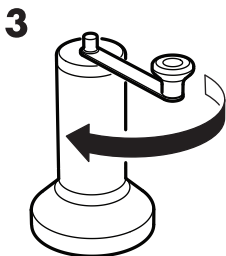
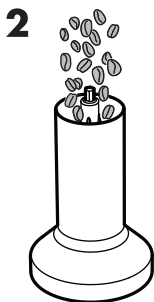
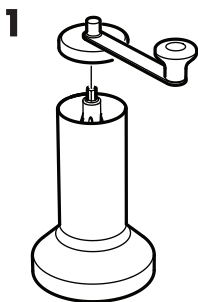

Návod na použitie

Nasypte do mlynčeka celé kávové zrná (3).

Zomel'te kávové zrná. Hrúbku mletia môžete nastaviť pootočením kolieska.

Odpojte nádobu na pomletú kávu a nasypte zomleté zrná do kávovaru.

Upevnite nádobu na pomletú kávu späť k mlynčeku.

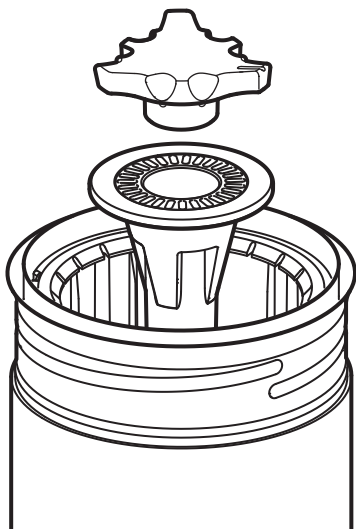

Čistenie

Odskrutkujte nastavovacie koliesko (proti smeru hodinových ručičiek) a odstráňte keramický brúsny kužeľ.

Vyčistite keramický brúsny kužeľ v horúcej vode.

Naskrutkujte nastavovacie koliesko (v smere hodinových ručičiek) na mlynček.

Prípravte si šálku kávy.

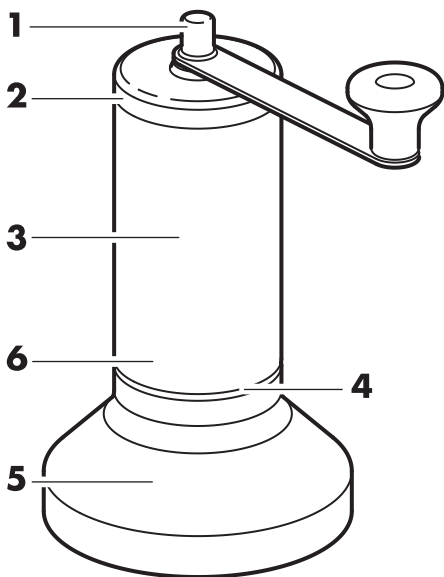

Илюстрация

- 1. Дръжка
- 2. Капак
- 3. Мелачка
- 4. Колело за настройка на смилането
- 5. Основа/Контейнер
- 6. Керамичен мелещ конус

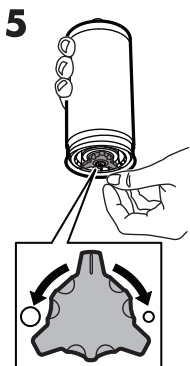
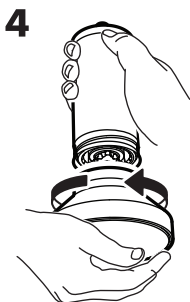
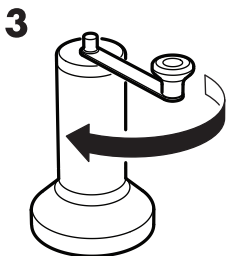
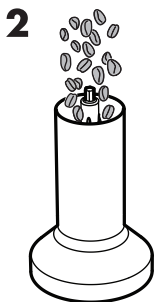
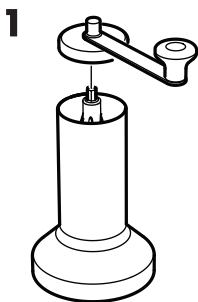

Начин на употреба

Сипете кафе на зърна в кафемелачката (3).

Смелете кафеените зърна. Можете да настроите степента на смилане, като завъртите колелото за настройване.

Отделете основата/контейнера и изсипете смляното кафе в кафеварката.

Поставете основата/контейнера обратно на кафемелачката

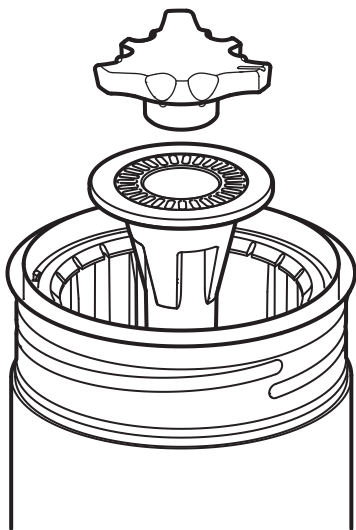

Почистване

Отвъртете колелото за настройване на степента на смилане (обратно на часовниковата стрелка) и извадете керамичния мелещ конус.

Почистете керамичния мелещ конус в топла вода.

Поставете и завийте отново колелото за настройване (по часовниковата стрелка) на кафемелачката.

Направете си чаша кафе.

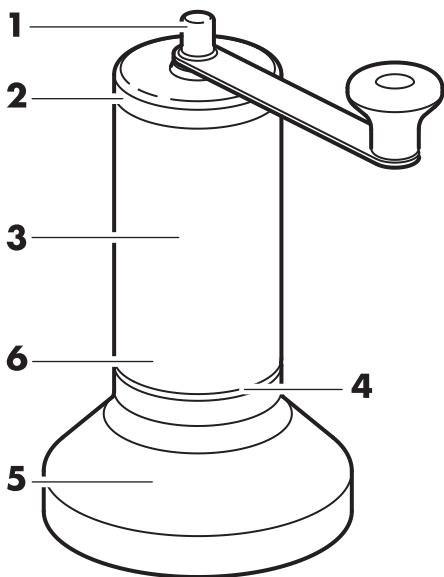
**Ilustracija**

1. Ručka
2. Poklopac
3. Mlinac
4. Kotačić za podešavanje
5. Podloga/posuda
6. Keramički stožac za mljevenje

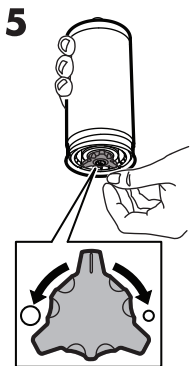
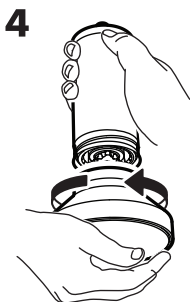
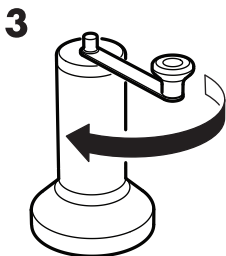
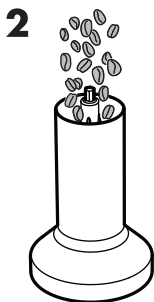
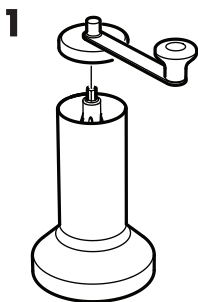

Kako koristiti

Napuniti mlinac zrnima kave (3).

Samljeti zrna kave. Grubost se može podesiti okretanjem kotačića za podešavanje.

Odvojiti podlogu/posudu i isuti mljevenu kavu u aparat za kavu.

Pričvrstiti podlogu/posudu natrag na mlinac.

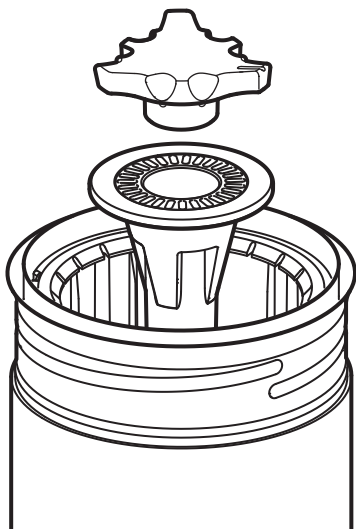

Čišćenje

Odviti kotačić za podešavanje (u smjeru suprotnom od kazaljke sata) i skinuti keramički stožac za mljevenje.

Očistiti keramički stožac za mljevenje u vrućoj vodi.

Zategnuti kotačić za podešavanje (u smjeru kazaljke sata) natrag na mlinac.

Uživaj u šalici svježeg mljevene kave.

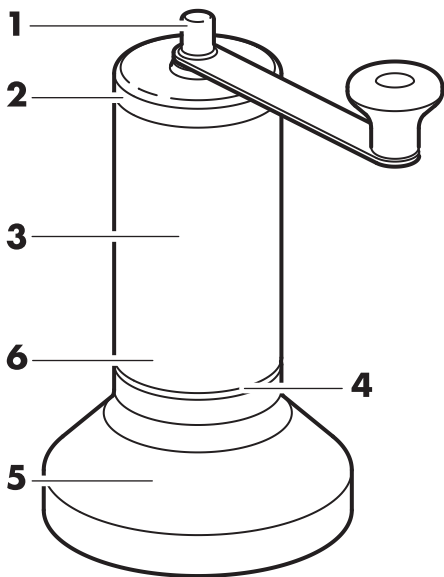
**Εικόνα**

1. Χερούλι
2. Καπάκι
3. Μύλος
4. Ρόδα ρύθμισης
5. Βάση/Συλλέκτης
6. Κεραμικός μηχανισμός αλέσματος

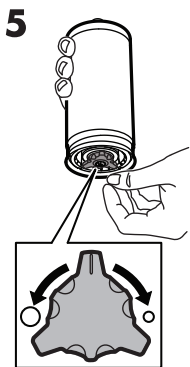
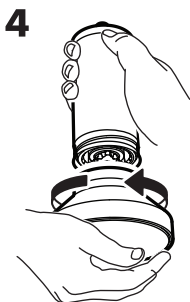
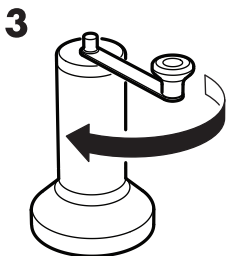
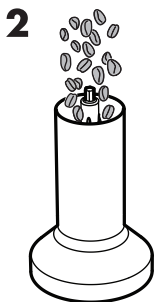
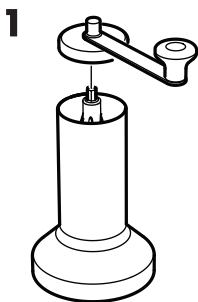

Οδηγίες χρήσης

Ρίξτε ολόκληρους κόκκους καφέ μέσα στον μύλο (3).

Αλέστε τους κόκκους καφέ. Μπορείτε να ρυθμίσετε την τραχύτητα χρησιμοποιώντας τη ρόδα ρύθμισης.

Αφαιρέστε την βάση/συλλέκτη και ρίξτε τους αλεσμένους κόκκους καφέ μέσα στην καφετιέρα.

Επανατοποθετήστε την βάση/συλλέκτη πάνω στο μύλο.

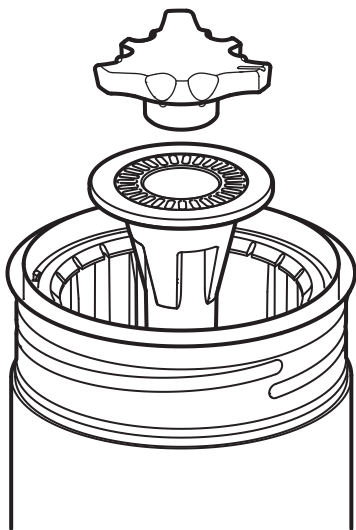

Φροντίδα

Ξεβιδώστε την ρόδα ρύθμισης (αριστερόστροφα) και αφαιρέστε τον κεραμικό μηχανισμό αλέσματος.

Καθαρίστε τον κεραμικό μηχανισμό αλέσματος κάτω από ζεστό νερό.

Επανατοποθετήστε την ρόδα ρύθμισης (δεξιόστροφα) πάνω στον μύλο.

Μπορείτε να φτιάξετε ένα φλυτζάνι καφέ.

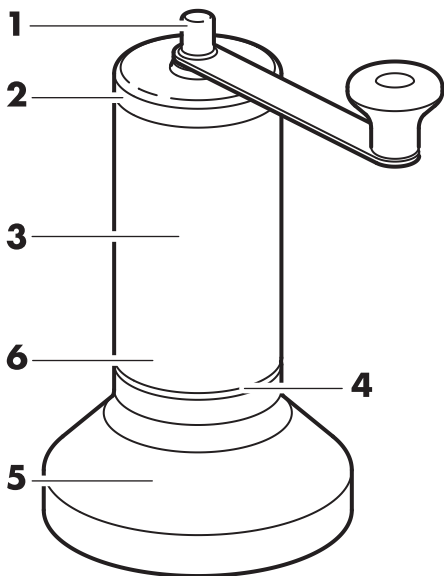

Рисунок

1. Ручка
2. Крышка
3. Мельничный отсек
4. Регулировочное колесико
5. Основание/контейнер
6. Керамический мельничный жернов

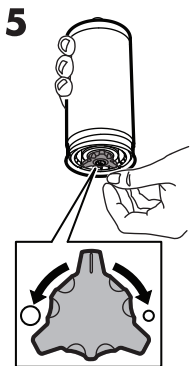
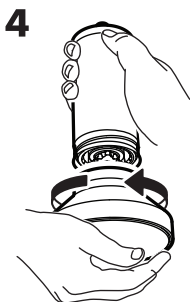
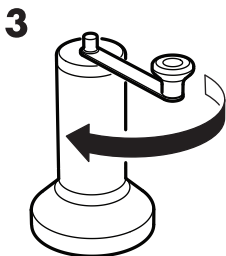
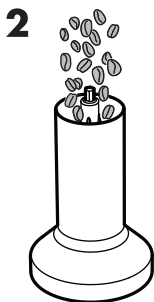
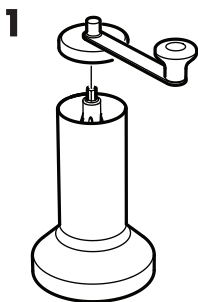

Как использовать

Засыпьте кофейные зерна в мельничный отсек (3).

Измельчите зерна. Вы можете регулировать степень помола, поворачивая регулировочное колесико.

Отсоедините основание/контейнер и высыпьте молотый кофе в кофеварку или турку.

Установите основание/контейнер на место.

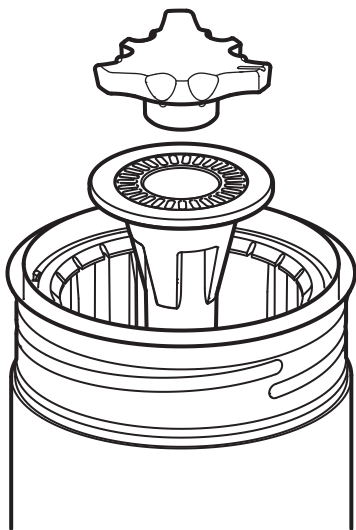
**Уход**

Поверните регулировочное колесико против часовой стрелки и снимите керамический мельничный жернов.

Промойте жернов в горячей воде.

Закрутите регулировочное колесико на мельничном отсеке по часовой стрелке.

Приготовьте кофе.

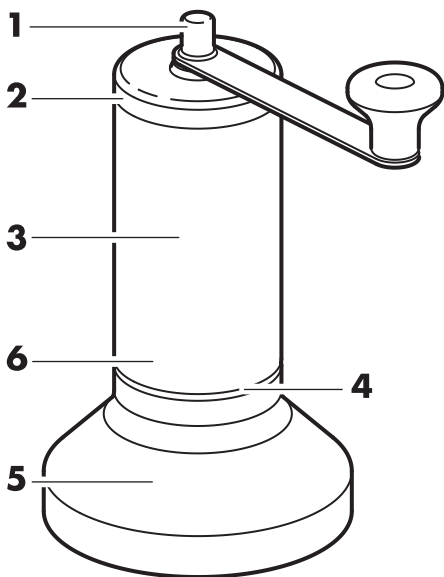
**Малюнок**

1. Ручка
2. Кришка
3. Млин
4. Колесо
5. Основа/колектор
6. Керамічні конусні жорна

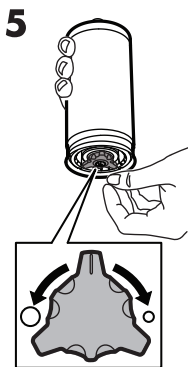
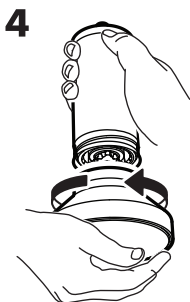
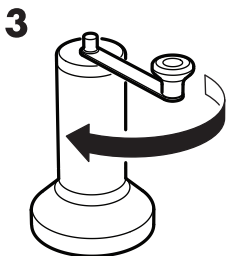
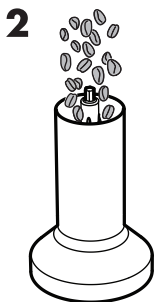
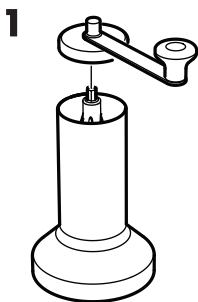

Як використовувати

Насипте кавові зерна до млина (3).

Перетріть кавові зерна. Поверніть колесо, щоб відрегулювати грубість помелу.

Дістаньте основу/колектор та пересипте перемелену каву до кавомашини.

Встановіть основу/колектор назад.

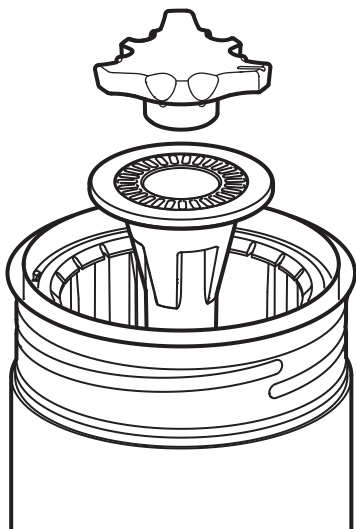

Чищення

Відкрутіть колесо (проти годинникової стрілки) та зніміть керамічні конусні жорна.

Промийте керамічні конусні жорна у гарячій воді.

Закрутіть колесо (за годинниковою стрілкою) назад на млин.

Зробіть собі чашечку кави.

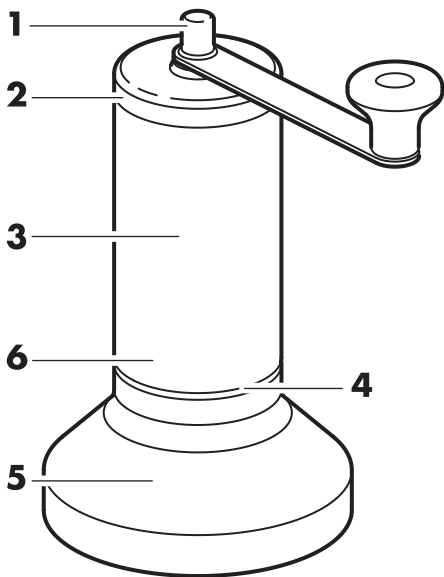
**Ilustracija**

1. Ručka
2. Poklopac
3. Mlin
4. Točkić za podešavanje
5. Osnova/posuda
6. Keramička kupa za mlevenje

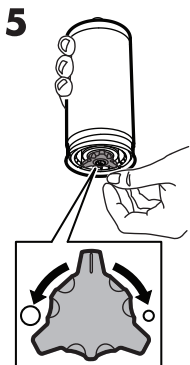
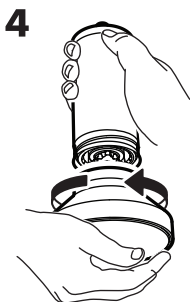
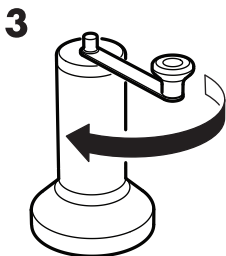
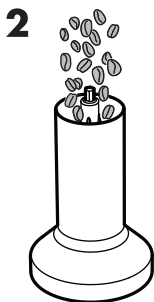
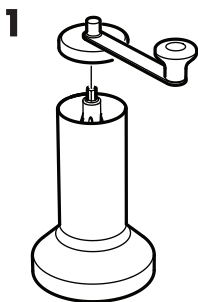

Upotreba

Napuni mlin celim zrnima kafe (3).

Samelji zrna kafe. Finoću mlevenja možeš podesiti okrećući točkić za podešavanje.

Odvoj osnovu/posudu i sipaj mlevena zrna kafe u aparat za kafu.

Vrati podlogu/posudu na mlin.

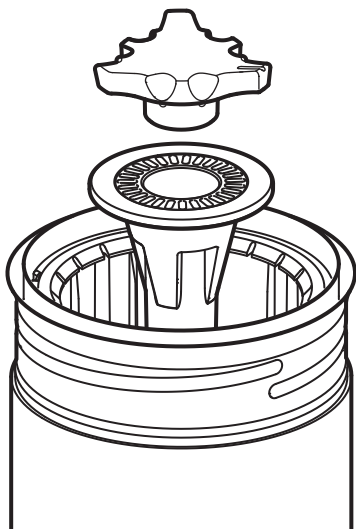

Čišćenje

Odvrni točkić za podešavanje (obrnuto od smera kazaljke) i ukloni keramičku kupu za mlevenje.

Očisti keramičku kupu za mlevenje vrućom vodom.

Zavrni točkić za podešavanje (u smeru kazaljke) na mlin.

Napravi sebi šolju kafe.

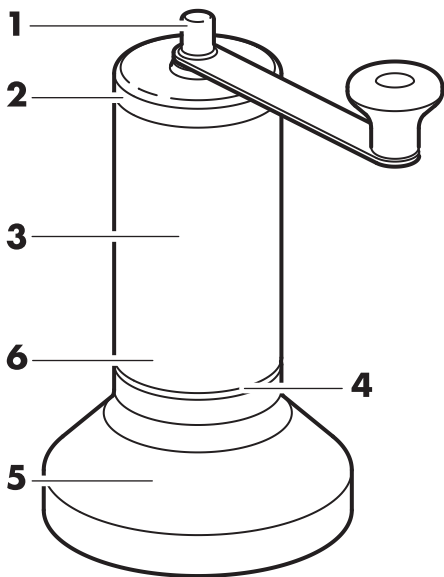
**Slike**

1. Ročaj
2. Pokrov
3. Mlinček
4. Nastavitveno kolesce
5. Podstavek/zbirna posoda
6. Keramični mlevni stožec

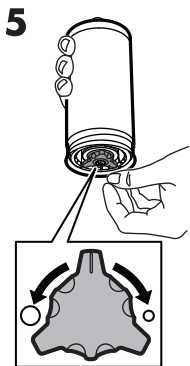
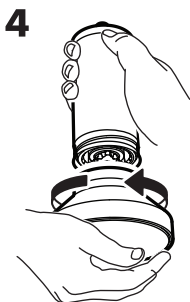
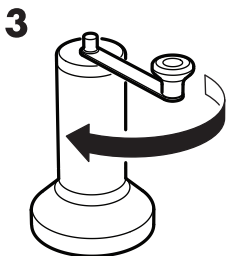
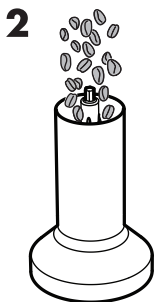
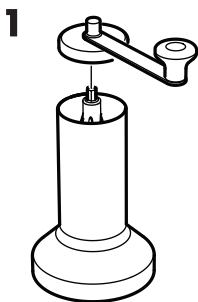

Uporaba

Vsuj cela kavna zrna v mlinček (3).

Zmelji kavna zrna. Grobost lahko nastaviš tako, da zasučeš nastavitveno kolesce.

Odstrani podnožje/zbirno posodo in vsuj zmleta kavna zrna v aparat za kavo.

Ponovno namesti podstavek/zbirno posodo na mlinček.

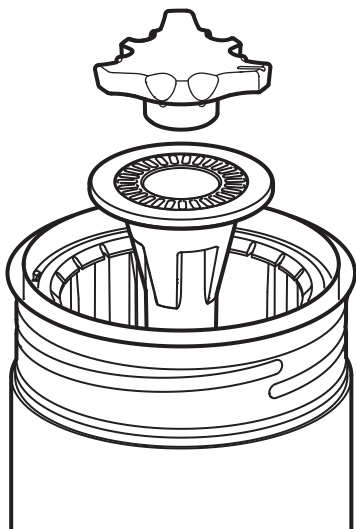

Čiščenje

Odvij nastavitveno kolesce (v nasprotni smeri urnega kazalca) in odstrani keramični mlevni stožec.

Keramični mlevni stožec očisti z vročo vodo.

Privij nastavitveno kolesce (v smeri urnega kazalca) nazaj na mlinček.

Pripravi si skodelico kave.

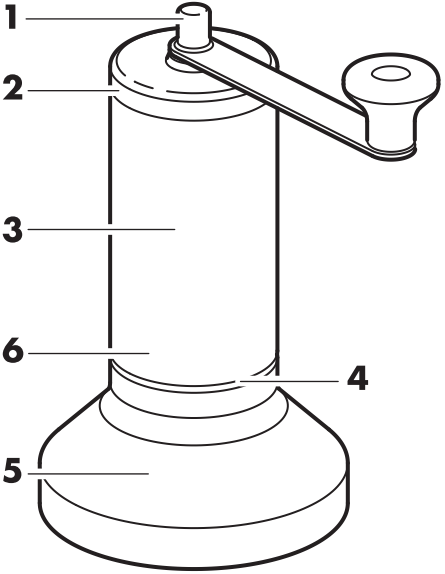
**İllüstrasyon**

1. Öğütme kolu
2. Kapak
3. Öğütücü
4. Ayarlanabilir dişli
5. Taban/Hazne
6. Konik seramik öğütücü

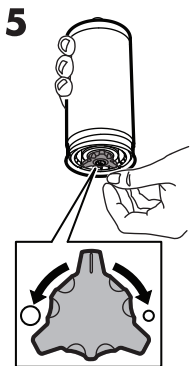
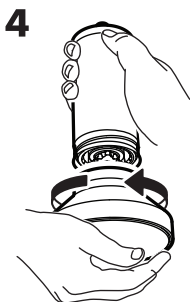
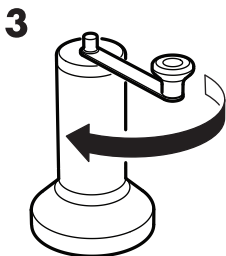
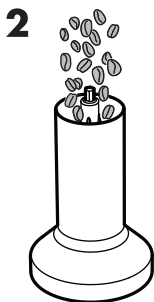
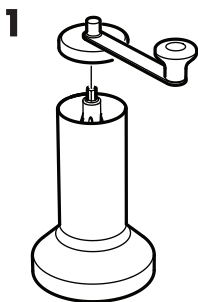

Kullanımı

Kahve çekirdeklerini öğütücünün içine boşaltın (3).

Kahve çekirdeklerini öğütün. Kahvenin ince ya da iri taneli olmasını ayarlanabilir dişliyi çevirerek sağlayın.

Taban ve hazne kısmını birbirinden ayırın ve öğütülmüş kahvenizi kahve makinenizin/ demliğinizin içine boşaltın.

Taban ve hazneyi tekrar birleştirin.

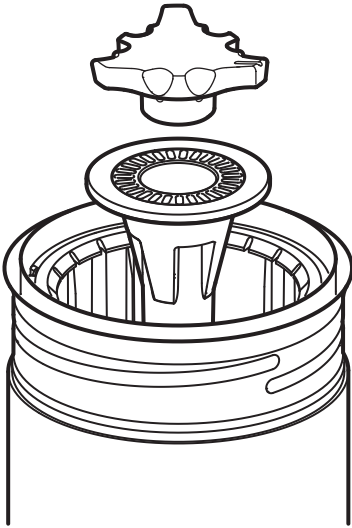
**Temizleme**

Ayarlanabilir dişliyi saatin tersi yönünde çevirerek sökün ve konik seramik öğütücüyü çıkartın.

Konik seramik öğütücüyü sıcak suyla yıkayın.

Ayarlanabilir dişliyi saat yönünde çevirerek takın.

Kendinize bir fincan kahve yapın.

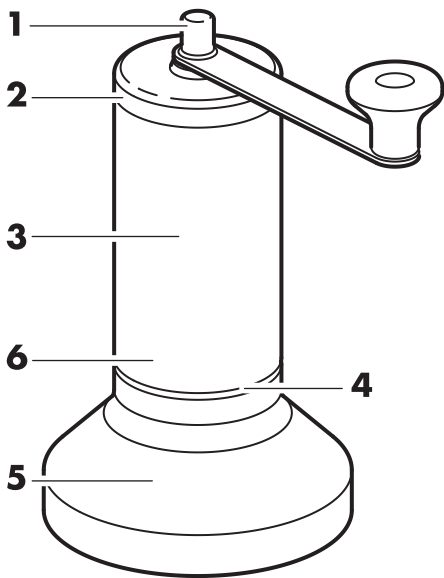

图示

1. 把手
2. 盖子
3. 磨豆机
4. 调节轮
5. 底座/咖啡粉槽
6. 陶瓷研磨锥

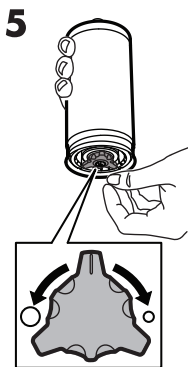
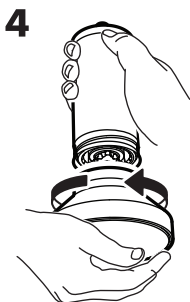
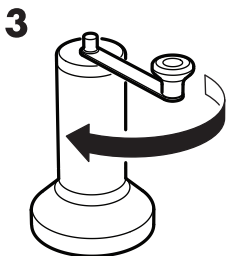
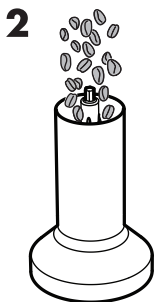
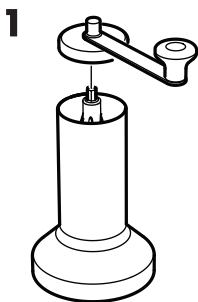

使用方法

将咖啡豆倒入磨豆机(3)。

研磨咖啡豆。你可以通过旋转调节轮来调整颗粒粗细。

卸下底座/咖啡粉槽,将研磨后的咖啡豆倒入咖啡机。

重新将底座/咖啡粉槽安装回去。

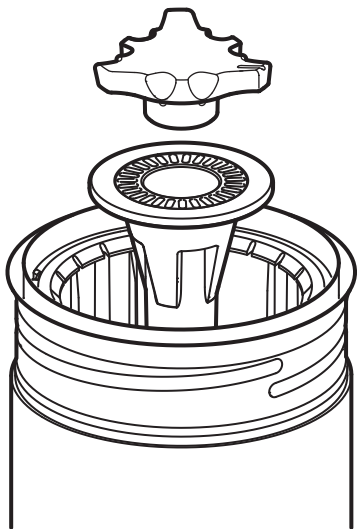

清洁说明

将调节轮旋开(逆时针方向),取出里面的陶瓷研磨锥。

将陶瓷研磨锥放入热水中清洁。

将调节轮旋转(顺时针方向)安装回磨豆机。

为自己制作一杯咖啡。

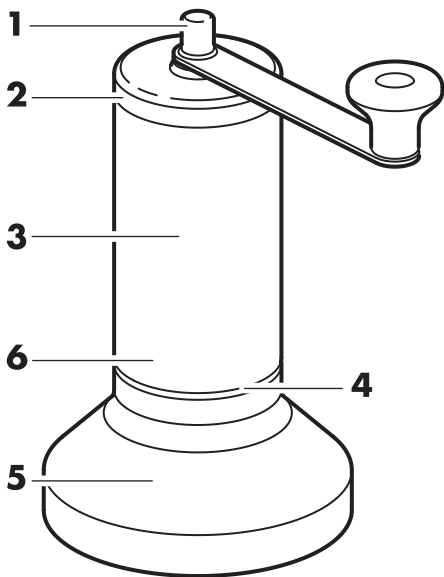

產品圖

1. 把手
2. 蓋子
3. 研磨槽
4. 調節旋鈕
5. 底座/咖啡粉槽
6. 陶瓷研磨錐

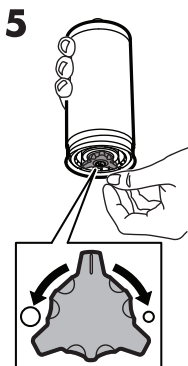
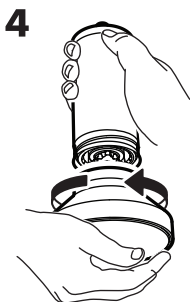
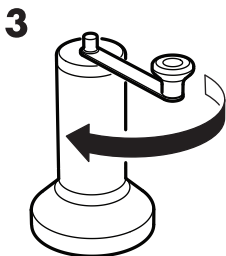
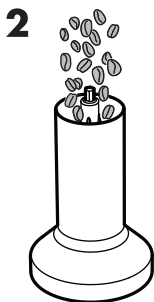
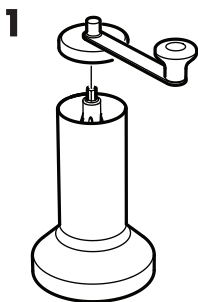

使用方法

將咖啡豆倒入研磨槽(3)。

研磨咖啡豆。你可以轉動調節旋鈕調整研磨粗細。

拆下底座/咖啡粉槽，將咖啡粉倒入咖啡機。

裝回底座/咖啡粉槽。

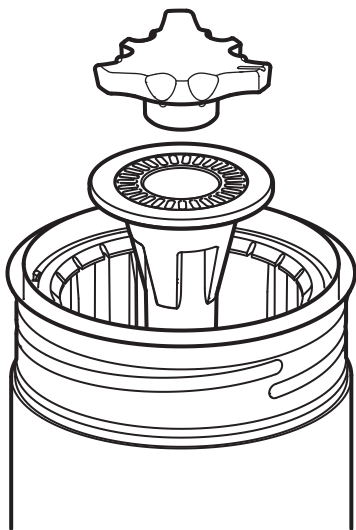

清潔說明

旋開調節旋鈕(逆時針方向)·拆下陶瓷研磨錐。

用熱水清洗陶瓷研磨錐。

裝回陶瓷研磨錐·旋緊調節旋鈕(順時針方向)。

即可沖泡咖啡。

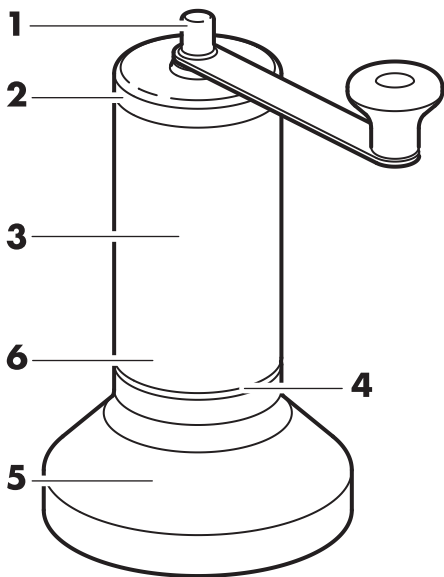

그림

1. 손잡이
2. 뚜껑
3. 그라인더
4. 조절바퀴
5. 받침/커피가루통
6. 세라믹 분쇄콘

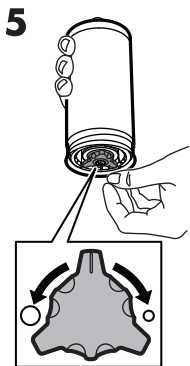
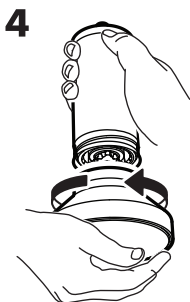
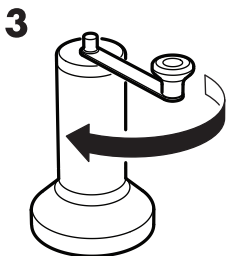
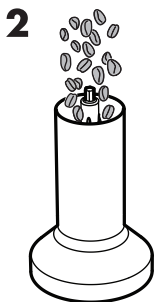
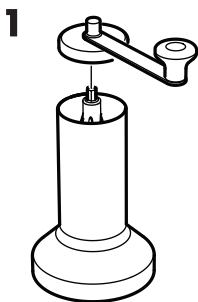

사용법

그라인더에 커피 원두를 넣습니다.

커피 원두를 분쇄합니다. 조절바퀴로 분쇄도를 조절할 수 있습니다.

받침/커피가루통을 분리해서 분쇄된 원두를 커피메이커에 붓습니다.

받침/커피가루통을 그라인더에 다시 끼웁니다.

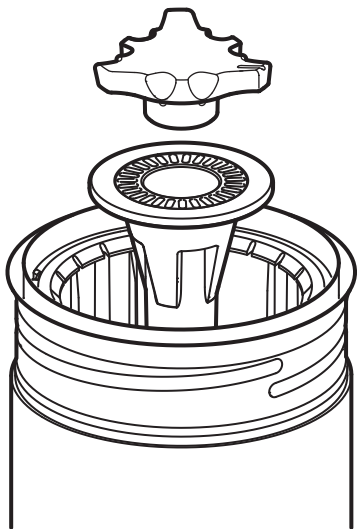

세척

조절바퀴의 나사를 시계 반대 방향으로 돌려서 풀고 세라믹 분쇄콘을 제거합니다.

세라믹 분쇄콘을 뜨거운 물로 세척합니다.

조절바퀴의 나사를 시계 방향으로 돌려 그라인더에 다시 끼웁니다.

이제 맛있는 커피를 즐기세요.

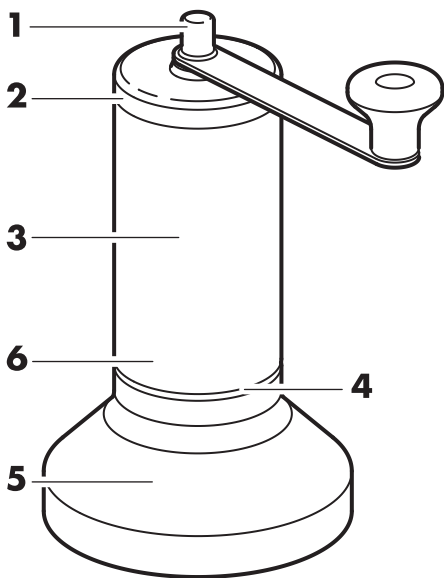

1. ハンドル
2. ふた
3. グライNDER
4. 粗さ調節ホイール
5. ベース/コレクター
6. セラミック製グライディングコーン

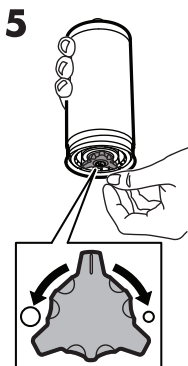
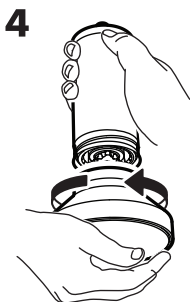
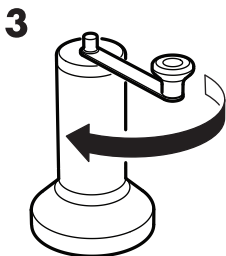
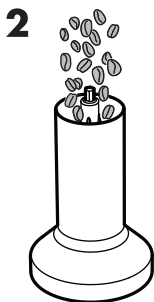
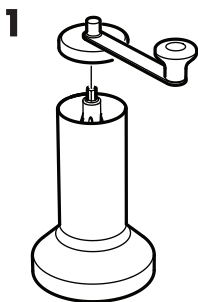

使用方法

グラインダー（3）にコーヒー豆を入れます。

コーヒー豆を挽きます。粗さ調節ホイールを回して挽き目の調節ができます。

ベース/コレクターを取り外し、挽いた豆をコーヒーメーカーに入れます。

ベース/コレクターを元どおりグラインダーに取り付けます。

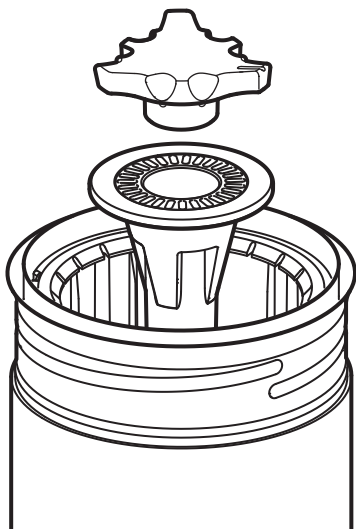

お手入れ方法

粗さ調節ホイールを外し（反時計回りに回す）、セラミック製グラインディングコーンを取り外します。

セラミック製グラインディングコーンをお湯につけて洗います。

粗さ調節ホイールを元どおりグラインダーに取り付けます（時計回りに回す）。

コーヒーを淹れます。

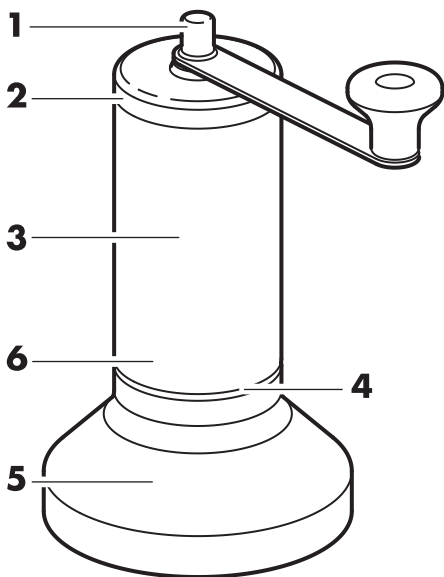
**Ilustrasi**

1. Gagang
2. Tutup
3. Penggiling
4. Roda penyesuai
5. Dasar/Kolektor
6. Kerucut penggilingan keramik

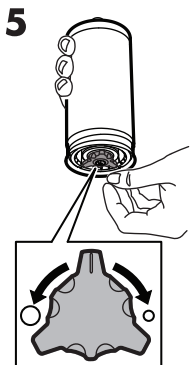
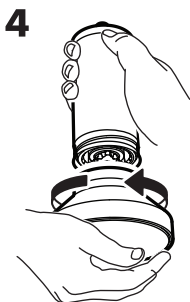
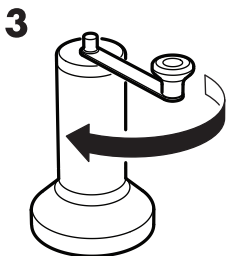
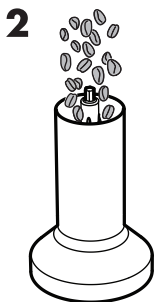
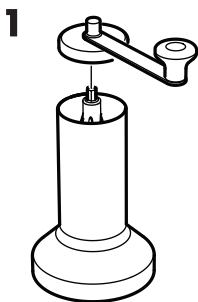

Cara penggunaan

Tuang biji kopi utuh ke dalam penggiling (3).

Giling biji kopi. Anda dapat menyesuaikan kekasaran dengan memutar roda penyesuaian.

Lepaskan dasar/kolektor dan tuangkan bubuk biji kopi ke dalam pembuat kopi.

Setel kembali dasar/kolektor pada penggiling.

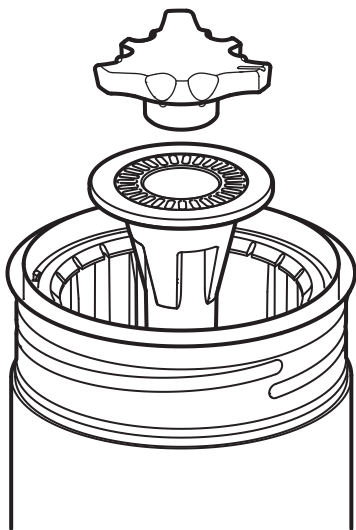
**Membersihkan**

Lepaskan roda penyesuaian (berlawanan arah jarum jam) dan lepaskan kerucut penggilingan keramik.

Bersihkan kerucut penggilingan keramik dengan air panas.

Setel kembali roda pengatan (searah jarum jam) ke grinder.

Buat secangkir kopi Anda sendiri.

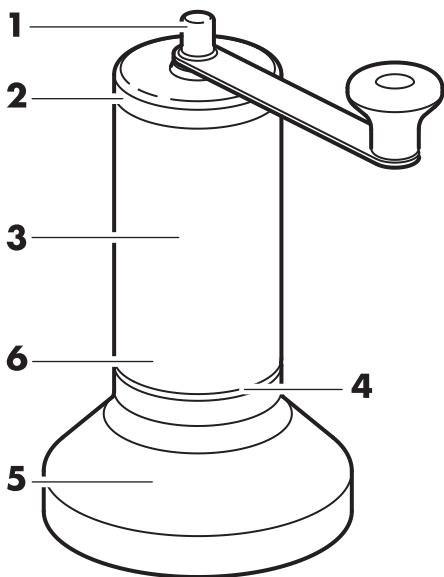
**Ilustrasi**

1. Pemegang
2. Penutup
3. Pengisar
4. Roda boleh laras
5. Dasar/Pengumpul
6. Kon pengisar seramik

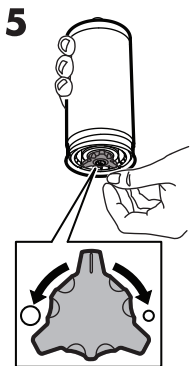
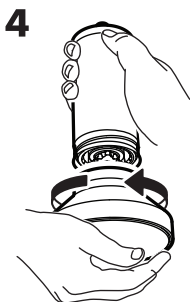
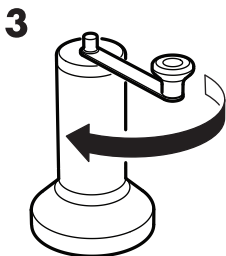
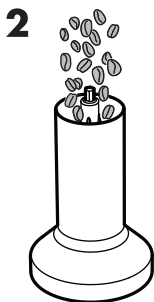
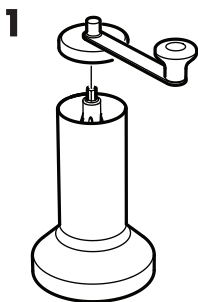

Cara penggunaan

Tuang semua biji kopi ke dalam pengisar (3).

Kisar biji kopi. Anda boleh laraskan kekasaran dengan memusing roda pelaras.

Tanggalkan dasar/pengumpul dan tuang biji kopi kisar ke dalam pembuat kopi.

Pasang semula dasar/pengumpul pada pengisar.

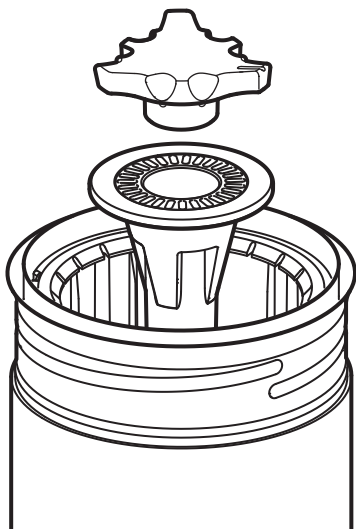

Pembersihan

Buka skru roda pelaras (lawan arah-jam) dan tanggalkan kon kisar seramik.

Bersih kon kisar seramik di dalam air panas.

Skru semula roda pelaras (arah jam) pada pengisar.

Buatkan secawan kopi untuk diri anda.

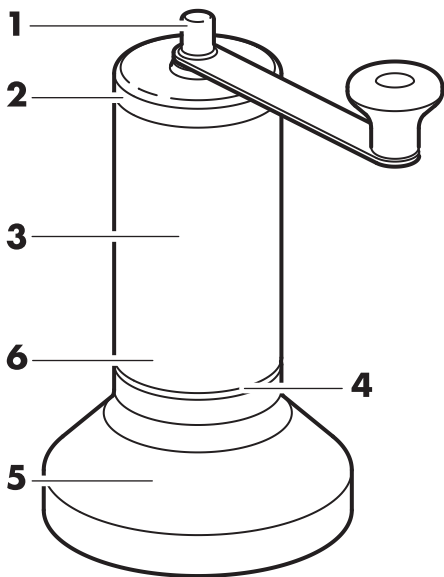

الرسم التوضيحي

1. اليد
2. الغطاء
3. الطاحونة
4. عجلة التعديل
5. القاعدة / وعاء التجميع
6. مخروط طحن من السيراميك

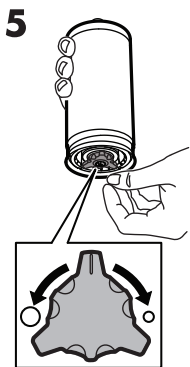
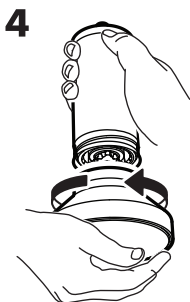
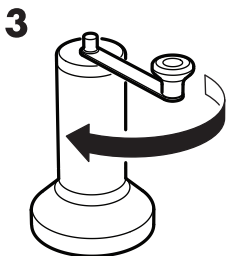
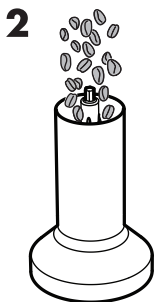
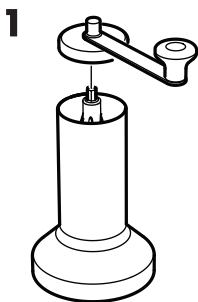

طريقة الاستخدام

ضعي حبوب البن داخل الطاحونة (3) .

اطحني حبوب البن. يمكنك ضبط خشونة الطحن بتدوير عجلة التعديل.

افصلي القاعدة / وعاء التجميع واسكبي البن المطحون في جهاز تحضير القهوة.

أعيدي تركيب القاعدة / وعاء التجميع مرة أخرى على المطحنة.

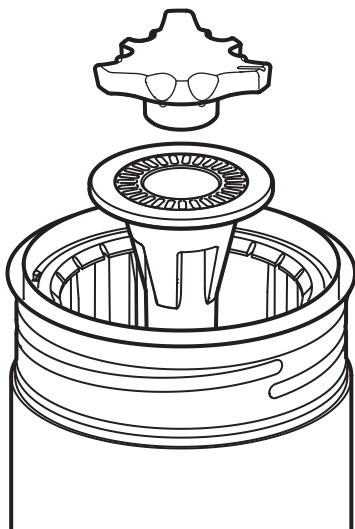

التنظيف

قومي بفك عجلة التعديل (عكس عقارب الساعة)
وإنزعي مخروط الطحن.

نظّفي مخروط الطحن بالماء الساخن.

أعيدي ربط عجلة التعديل (في اتجاه عقارب الساعة)
على الطاحونة.

اصنعي لنفسك فنجاناً من القهوة.

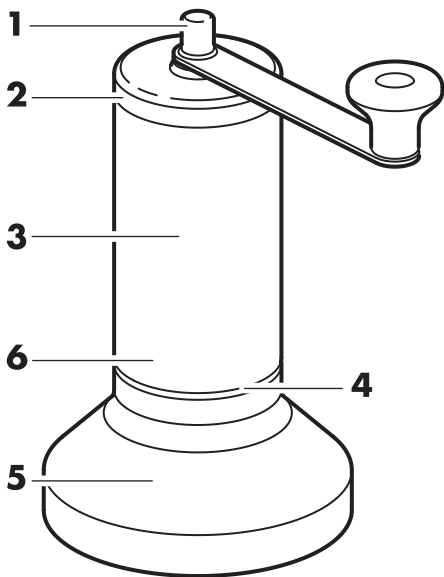
**ภาพประกอบ**

1. มือจับ
2. ฝาปิด
3. ที่บด
4. ล้อปรับความละเอียด-หยาบ
5. ฐาน/ที่ใส่ผงกาแฟบด
6. เฟืองบดเซรามิก

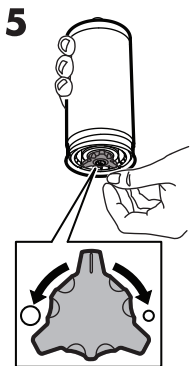
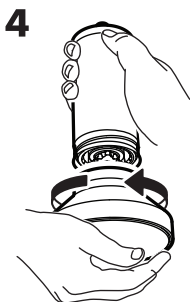
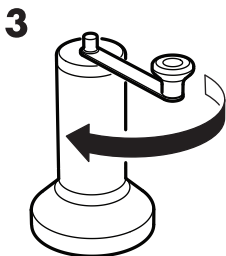
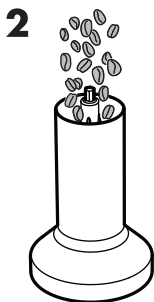
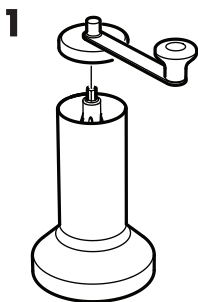

วิธีใช้

เทเมล์ดกาแฟใส่ในที่บด (3)

บดเมล์ดกาแฟ หมุนล้อปรับความละเอียด-หยาบ เพื่อให้ผงกาแฟมีเนื้อละเอียดหรือหยาบตามต้องการ

ถอดฐาน/ที่ใส่ผงกาแฟบดออกจากเครื่องบด และเทผงกาแฟบดใส่ในเครื่องทำกาแฟ

ใส่ฐาน/ที่ใส่ผงกาแฟบดกลับเข้าเครื่องบดเมล์ดกาแฟตามเดิม

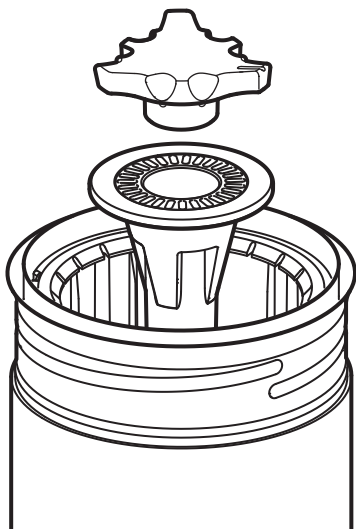

วิธีทำความสะอาด

ถอดล้อปรับความละเอียด-หยาบ (หมุนทวนเข็มนาฬิกา)
และเฟืองบดเซรามิกจากเครื่องบด

ทำความสะอาดเฟืองบดเซรามิกในน้ำร้อน

ใส่ล้อปรับความละเอียด-หยาบกลับเข้าเครื่องบด (หมุน
ตามเข็มนาฬิกา)

ชงกาแฟสูตรของคุณเองดื่ม

