

ID

KR

SMAKSAK

105.082.58



Design and Quality
IKEA of Sweden



ENGLISH

For the IKEA appointed Authorized Service Centre, please refer to www.IKEA.com and select your local store for phone numbers and opening times.

ENGLISH

4

Contents

Safety information	4	Additional functions	16
Safety instructions	6	Hints and tips	16
Installation	8	Care and cleaning	21
Product description	9	Troubleshooting	24
Control panel	9	Technical data	25
Before first use	10	Energy efficiency	26
Daily use	11	Environmental concerns	27
Clock functions	13	IKEA GUARANTEE	27
Using the accessories	14		

Subject to change without notice.

Safety information

Before the installation and use of the appliance, carefully read the supplied instructions. The manufacturer is not responsible if an incorrect installation and use causes injuries and damage. Always keep the instructions with the appliance for future reference.

Children and vulnerable people safety

- This appliance can be used by children aged from 8 years and above and persons with reduced physical, sensory or mental capabilities or lack of experience and knowledge if they have been given supervision or instruction concerning the use of the appliance in a safe way and understand the hazards involved. Children of less than 8 years of age and persons with very extensive and complex disabilities shall be kept away from the appliance unless continuously supervised.
- Children should be supervised to ensure that they do not play with the appliance.
- Keep all packaging away from children and dispose of it appropriately.

- **WARNING:** Keep children and pets away from the appliance when it operates or when it cools down. Accessible parts become hot during use.
- If the appliance has a child safety device, it should be activated.
- Children shall not carry out cleaning and user maintenance of the appliance without supervision.

General Safety

- Only a qualified person must install this appliance and replace the cable.
- **WARNING:** The appliance and its accessible parts become hot during use. Care should be taken to avoid touching heating elements.
- Always use oven gloves to remove or put in accessories or ovenware.
- Before any maintenance, cut the power supply.
- **WARNING:** Ensure that the appliance is switched off before replacing the lamp to avoid the possibility of electric shock.
- Do not use the appliance before installing it in the built-in structure.
- Do not use a steam cleaner to clean the appliance.
- Do not use harsh abrasive cleaners or sharp metal scrapers to clean the glass door since they can scratch the surface, which may result in shattering of the glass.
- If the mains power supply cable is damaged, it must be replaced by the manufacturer, its Authorised Service Centre or similarly qualified persons to avoid an electrical hazard.
- To remove the shelf supports first pull the front of the shelf support and then the rear end away from the side walls. Install the shelf supports in the opposite sequence.
- The means for disconnection must be incorporated in the fixed wiring in accordance with the wiring rules.

Safety instructions

Installation

⚠ Warning! Only a qualified person must install this appliance.

- Remove all the packaging.
- Do not install or use a damaged appliance.
- Follow the installation instructions supplied with the appliance.
- Always take care when moving the appliance as it is heavy. Always use safety gloves and enclosed footwear.
- Do not pull the appliance by the handle.
- Install the appliance in a safe and suitable place that meets installation requirements.
- Keep the minimum distance from other appliances and units.
- Before mounting the appliance, check if the oven door opens without restraint.

Cabinet minimum height (Cabinet under the worktop minimum height)	580 (600) mm
Cabinet width	560 mm
Cabinet depth	550 (550) mm
Height of the front of the appliance	589 mm
Height of the back of the appliance	571 mm
Width of the front of the appliance	595 mm
Width of the back of the appliance	559 mm
Depth of the appliance	569 mm
Built in depth of the appliance	548 mm
Depth with open door	1022 mm

Ventilation opening minimum size. Opening placed on the bottom rear side	560x20 mm
Mounting screws	2x25 mm

Electrical connection

⚠ Warning! Risk of fire and electric shock.

- All electrical connections should be made by a qualified electrician.
- The appliance must be earthed.
- Make sure that the parameters on the rating plate are compatible with the electrical ratings of the mains power supply.
- Always use a correctly installed shockproof socket.
- Do not use multi-plug adapters and extension cables.
- Make sure not to cause damage to the mains plug and to the mains cable. Should the mains cable need to be replaced, this must be carried out by our Authorised Service Centre.
- Do not let mains cables touch or come near the appliance door or the niche below the appliance, especially when it operates or the door is hot.
- The shock protection of live and insulated parts must be fastened in such a way that it cannot be removed without tools.
- Connect the mains plug to the mains socket only at the end of the installation. Make sure that there is access to the mains plug after the installation.
- If the mains socket is loose, do not connect the mains plug.
- Do not pull the mains cable to disconnect the appliance. Always pull the mains plug.
- Use only correct isolation devices: line protecting cut-outs, fuses (screw type fuses removed from the holder), earth leakage trips and contactors.

- The electrical installation must have an isolation device which lets you disconnect the appliance from the mains at all poles. The isolation device must have a contact opening width of minimum 3 mm.

Use



Warning! Risk of injury, burns and electric shock or explosion.

- This appliance is for household (indoors) use only.
- Do not change the specification of this appliance.
- Make sure that the ventilation openings are not blocked.
- Do not let the appliance stay unattended during operation.
- Deactivate the appliance after each use.
- Be careful when you open the appliance door while the appliance is in operation. Hot air can release.
- Do not operate the appliance with wet hands or when it has contact with water.
- Do not apply pressure on the open door.
- Do not use the appliance as a work surface or as a storage surface.
- Open the appliance door carefully. The use of ingredients with alcohol can cause a mixture of alcohol and air.
- Do not let sparks or open flames to come in contact with the appliance when you open the door.
- Do not put flammable products or items that are wet with flammable products in, near or on the appliance.



Warning! Risk of damage to the appliance.

- To prevent damage or discoloration to the enamel:
 - do not put ovenware or other objects in the appliance directly on the bottom.
 - do not put aluminium foil directly on the bottom of cavity of the appliance.
 - do not put water directly into the hot appliance.

- do not keep moist dishes and food in the appliance after you finish the cooking.
- be careful when you remove or install the accessories.
- Discoloration of the enamel or stainless steel has no effect on the performance of the appliance.
- Use a deep pan for moist cakes. Fruit juices cause stains that can be permanent.
- This appliance is for cooking purposes only. It must not be used for other purposes, for example room heating.
- Always cook with the oven door closed.
- If the appliance is installed behind a furniture panel (e.g. a door) make sure the door is never closed when the appliance operates. Heat and moisture can build up behind a closed furniture panel and cause subsequent damage to the appliance, the housing unit or the floor. Do not close the furniture panel until the appliance has cooled down completely after use.

Care and Cleaning



Warning! Risk of injury, fire, or damage to the appliance.

- Before maintenance, deactivate the appliance and disconnect the mains plug from the mains socket.
- Make sure the appliance is cold. There is a risk that the glass panels can break.
- Replace immediately the door glass panels when they are damaged. Contact the Authorised Service Centre.
- Be careful when you remove the door from the appliance. The door is heavy!
- Clean regularly the appliance to prevent the deterioration of the surface material.
- Fat and food remaining in the appliance can cause fire.
- If you use an oven spray, obey the safety instructions on the packaging.
- Do not remove the knobs from the appliance.

Internal lighting

⚠ Warning! Risk of electric shock.

- Concerning the lamp(s) inside this product and spare part lamps sold separately: These lamps are intended to withstand extreme physical conditions in household appliances, such as temperature, vibration, humidity, or are intended to signal information about the operational status of the appliance. They are not intended to be used in other applications and are not suitable for household room illumination.
- Use only lamps with the same specifications.

Service

- To repair the appliance contact the Authorised Service Centre.

- Use original spare parts only.

Disposal

⚠ Warning! Risk of injury or suffocation.

- Disconnect the appliance from the mains supply.
- Cut off the mains electrical cable close to the appliance and dispose of it.
- Remove the door to prevent children and pets to get closed in the appliance.
- Packaging material:**
The packaging material is recyclable. Plastic parts are marked with international abbreviations such as PE, PS, etc. Dispose of the packaging material in the containers provided for this purpose at your local waste management facility.

Installation

⚠ Warning! Refer to Safety chapters.

Assembly

i Refer to the Assembly Instructions for the installation.

Electrical installation

⚠ Warning! Only a qualified person must do the electrical installation.

i The manufacturer is not responsible if you do not follow the safety precautions from the Safety chapters.

H07 RN-F, H05 RN-F, H05 RRF, H05 VV-F, H05 V2V2-F (T90), H05 BB-F

For the section of the cable refer to the total power on the rating plate. You can also refer to the table:

Total power (W)	Section of the cable (mm ²)
maximum 1380	3 x 0.75
maximum 2300	3 x 1
maximum 3680	3 x 1.5

The earth cord (green / yellow cable) must be 2 cm longer than phase and neutral cables (blue and brown cables).

This oven is supplied without a main plug and a main cable.

Cable

Cable types applicable for installation or replacement:

Product description

General overview

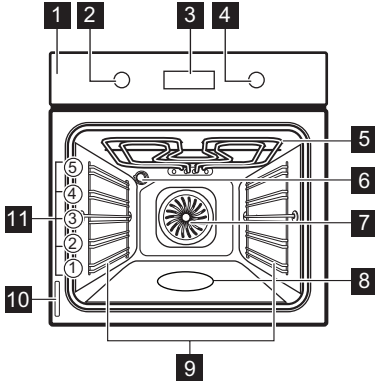

- 1 Control panel
- 2 Knob for the heating functions
- 3 Display
- 4 Control knob
- 5 Heating element
- 6 Lamp
- 7 Fan
- 8 Cavity embossment
- 9 Shelf support, removable
- 10 Rating plate
- 11 Shelf positions

Accessories

- **Wire shelf** x 1
For cookware, cake tins, roasts.
- **Baking tray** x 1
For cakes and biscuits.

- **Grill- / Roasting pan** x 1
To bake and roast or as pan to collect fat.
- **Telescopic runners** x 1 set
For shelves and trays.

Control panel

Buttons

Sensor field / Button	Function	Description
	OPTIONS	To set the clock functions. To check the oven temperature. Use only while a heating function operates.
START	START	To start a heating function.
OK	OK	To confirm.

Display

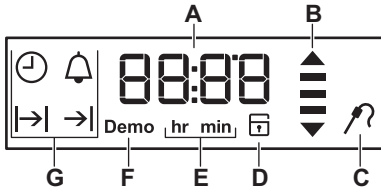

- A. Timer / Temperature
- B. Heat-up and residual heat indicator
- C. Core temperature sensor (selected models only)
- D. Door lock (selected models only)
- E. Hours / minutes
- F. Demo mode (selected models only)
- G. Clock functions

Before first use

- Warning!** Refer to Safety chapters.
- To set the Time of day refer to "Clock functions" chapter.

Initial Cleaning

Remove all accessories and removable shelf supports from the oven.

Refer to "Care and cleaning" chapter.

Clean the oven and the accessories before the first use.

Put the accessories and the removable shelf supports back to their initial position.

Preheating

Preheat the empty oven before first use.

- For function: Direct Steam refer to "Daily use" chapter, Setting the function: Direct Steam".

1. Set the function . Set the maximum temperature.
2. Let the oven operate for 1 hour.
3. Set the function . Set the maximum temperature.
4. Let the oven operate for 15 minutes.
5. Turn off the oven and let it cool down. Accessories can become hotter than usual. The oven can emit an odour and smoke. Make sure that the airflow in the room is sufficient.

Using the Mechanical child lock

The oven has the child lock installed. It is on the right side of the oven, below the control panel.

To open the oven door with the child lock:

1. Pull and hold the child lock handle up as shown in the picture.

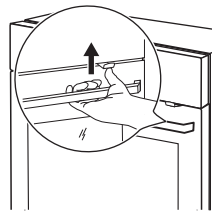

2. Open the door. Close the oven door without pulling the child lock.

To remove the child lock, open the oven door and remove the child lock with the torx key. The torx key is in the oven fitting bag.

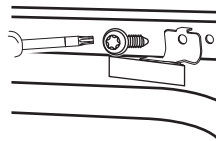







Screw back the screw into the hole after removing the child lock.



 **Warning!** Be careful not to scratch the control panel.



Daily use

 **Warning!** Refer to Safety chapters.

Heating functions

Heating function	Application
 Off position	The oven is off.
 Forced Air Cooking	To bake on up to three shelf positions at the same time and to dry food. Set the temperature 20 - 40 °C lower than for Conventional (Top and Bottom Heat).
 Conventional (Top and Bottom Heat)	To bake and roast food on one shelf position.
 Fast Grilling	To grill flat food in large quantities and to toast bread.
 Bottom Heat	To bake cakes with crispy bottom and to preserve food.
 Grilling with Fan	To roast larger meat joints or poultry with bones on one shelf position. To make gratins and to brown.

Heating function	Application
 Bread and Pizza Baking	To bake pizza. To make intensive browning and a crispy bottom.
 Defrost	To defrost food (vegetables and fruit). The defrosting time depends on the amount and size of the frozen food. When you use this function the lamp automatically turns off after 30 seconds.
 Direct Steam	To add humidity during the cooking. To get the right colour and crispy crust during baking. To give more juiciness during reheating.

Heating function	Application
 <p>Eco Fan Cooking</p>	<p>This function is designed to save energy during cooking. For the cooking instructions refer to "Hints and tips" chapter, Eco Fan Cooking. The oven door should be closed during cooking so that the function is not interrupted and to ensure that the oven operates with the highest energy efficiency possible. When you use this function, the temperature in the cavity may differ from the set temperature. The residual heat is used. The heating power may be reduced. For general energy saving recommendations refer to "Energy Efficiency" chapter, Energy Saving. This function was used to comply with the energy efficiency class according to EN 60350-1. When you use this function the lamp automatically turns off after 30 seconds.</p>
 <p>Light</p>	<p>To turn on the lamp without a cooking function. It can be used with residual heat in final cooking phase to save energy.</p>

Setting a heating function

1. Turn the knob for the heating functions to select a heating function.
2. Turn the control knob to select the temperature. Press **START** to confirm. The lamp turns on when the oven operates.
3. To turn off the oven, turn the knob for the heating functions to the off position. Turn the control knob to change the temperature during cooking. Turn the knob for the heating function to change a heating function during cooking and press **START** to confirm.

Setting the function: Direct Steam

This function increases humidity during cooking.

Warning! Risk of burns and damage to the appliance.

Released humidity can cause burns. Do not open the oven door when the function works. After the function stops, carefully open the door.

1. Fill the cavity embossment with tap water.

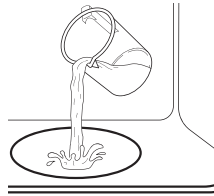

The maximum capacity of the cavity embossment is 250 ml. Fill the cavity embossment with water only when the oven is cold.

Caution! Do not refill the cavity embossment during cooking or when the oven is hot.

2. Put food in the oven and close the oven door.

Refer to "Hints and tips" chapter.

3. Set the function: Direct Steam .
4. Turn the control knob to set temperature. Press **START** to confirm.
5. Turn the knob for the heating functions to the off position to turn off the oven.
6. Remove water from the cavity embossment.

Warning! Make sure that the oven is cold before you remove the remaining water from the cavity embossment.





Heat-up indicator

When the oven function operates, the bars in the display  appear one by one when

the temperature in the oven increases, and disappear when it decreases.

Clock functions

Clock functions table

Clock function	Application
 TIME OF DAY	To show or change the time of day. You can change the time of day only when the oven is off.
 DURATION	To set how long the oven works. Use only when a heating function is set.
 END	To set when the oven turns off. Use only when a heating function is set.
 TIME DELAY	Combination of DURATION and END function.
 MINUTE MINDER	Use to set a countdown time. This function has no effect on the operation of the oven. You can set the MINUTE MINDER at any time, also if the oven is off.
00:00 COUNT UP TIMER	If you do not set any other clock function the COUNT UP TIMER automatically monitor how long the oven works. The counting starts immediately when the oven starts to heat. The Count Up Timer cannot be used with the functions: DURATION, END.

Setting and changing the time



After the first connection to the mains, wait until the display shows **hr** and "12:00". "12" flashes.

1. Turn the control knob to set the hours.
2. Press  to confirm and set the minutes.



The display shows **min** and the set hour. "00" flashes.

3. Turn the control knob to set the current minutes.
4. Press **OK** to confirm or the set time of day will be saved automatically after 5 seconds.

The display shows the new time.

To change the time of day press  again and again until the indicator for the time of day  flashes in the display.

Setting the DURATION function



1. Set a heating function. Press **START** to confirm.
2. Press  again and again until  starts to flash.
3. Turn the control knob to set the minutes and press  to confirm. Turn the control knob to set the hours and press **OK** to confirm.

When the set Duration time ends the signal sounds for 2 minutes.  and time setting flash in the display. The oven turns off automatically.

4. Press any button to stop the signal.
5. Turn the knob for the heating functions to the off position.

This function is not available for some oven functions.

Setting the END function





1. Set a heating function. Press **START** to confirm.
2. Press  again and again until  starts to flash.
3. Turn the control knob to set the hours and press  to confirm. Turn the control knob to set the minutes and press **OK** to confirm.

At the set End time the signal sounds for 2 minutes.  and time setting flash in the display. The oven turns off automatically.





4. Press any button to stop the signal.
5. Turn the knob for the heating functions to the off position.

This function is not available for some oven functions.

Setting the TIME DELAY function

1. Set a heating function. Press **START** to confirm.
2. Press  again and again until  starts to flash.
3. Turn the control knob to set the minutes for DURATION time and press  to confirm. Turn the control knob to set the hours for DURATION time and press  to confirm.

The display shows flashing .

4. Turn the control knob to set the hours for END time and press  to confirm. Turn the control knob to set the minutes for END time and press  to confirm. The display shows  and the set temperature.

Oven turns on automatically later on, works for the set DURATION time and stops at the set END time.

At the set END time the signal sounds for 2 minutes.  and time setting flash in the display. The oven turns off.







5. Press any button to stop the signal.
6. Turn the knob for the heating functions to the off position.

You can change the heating function and the temperature after you set the TIME DELAY function.

Turn the knobs to the off positions to stop the TIME DELAY function.

Setting the MINUTE MINDER

Minute minder can be both set when the oven is turned on and off.

1. Press  again and again until  starts to flash.
2. Turn the control knob to set the seconds and than the minutes.
 - Press  one more time to set the minutes
 - Press  two more times to set the hours
3. Press  to confirm.
4. The MINUTE MINDER starts automatically after 5 seconds. After 90% of the set time the signal sounds.
5. When the set time ends the signal sounds for 2 minutes. "00:00" and  flash in the display. Press any button to stop the signal.

COUNT UP TIMER

Press  again and again until the display shows time without any symbols.

Using the accessories



Warning! Refer to Safety chapters.

Inserting the accessories

Wire shelf:

Push the shelf between the guide bars of the shelf support and make sure that the feet point down.

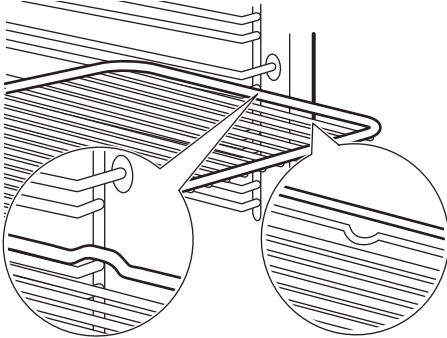

Baking tray/ Deep pan:

Push the baking tray / deep pan between the guide bars of the shelf support.

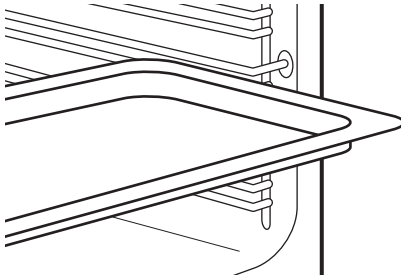

Wire shelf and baking tray / deep pan together:

Push the baking tray / deep pan between the guide bars of the shelf support and the wire shelf on the guide bars above.

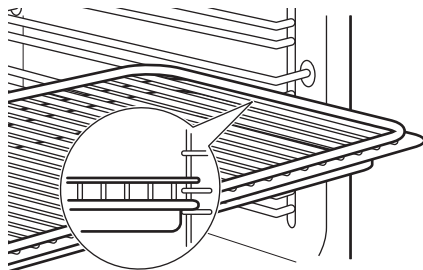

i Small indentation at the top increase safety. The indentations are also anti-tip devices. The high rim around the shelf prevents cookware from slipping of the shelf.

Using the telescopic runners

i Keep the installation instructions for the telescopic runners for future use.

With telescopic runners you can put in and remove wire shelves and trays easily.

⚠ Caution! Do not clean the telescopic runners in the dishwasher. Do not lubricate the telescopic runners.

1

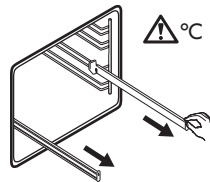

Pull out the right and left hand telescopic runners.

2

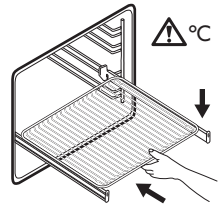

Put the wire shelf on the telescopic runners and carefully push them into the oven.

Make sure you push back the telescopic runners fully in the oven before you close the oven door.

⚠ Warning! Refer to "Product description" chapter.

Additional functions

Using the Child Lock

When the Child Lock is on the oven cannot be turned on accidentally.

1. Ensure the knob for the oven functions is in the off position.
2. Press and hold **START** and **OK** at the same time for 2 seconds. The signal sounds. **SAFE** appears on the display.
To turn off the Child Lock, repeat step 2.

Residual heat indicator

When you turn off the oven, the display shows the residual heat indicator  if the temperature in the oven is more than 40 °C. Turn the control knob left or right to check the oven temperature.

Automatic Switch-off

For safety reasons the oven turns off automatically after some time if a heating function operates and you do not change the oven temperature.

Temperature (°C)	Switch-off time (h)
30 - 115	12.5

Temperature (°C)	Switch-off time (h)
120 - 195	8.5
200 - 245	5.5
250 - maximum	3

After an automatic switch-off, press any button to operate the oven again.



The Automatic switch-off does not work with the functions: Light, Duration, End.

Cooling fan

When the oven operates, the cooling fan turns on automatically to keep the surfaces of the oven cool. If you turn off the oven, the cooling fan can continue to operate until the oven cools down.

Safety thermostat

Incorrect operation of the oven or defective components can cause dangerous overheating. To prevent this, the oven has a safety thermostat which interrupts the power supply. The oven turns on again automatically when the temperature drops.

Hints and tips



Warning! Refer to Safety chapters.

Cooking recommendations

Whenever preheating, remove the wire shelves and trays from the cavity to have the fastest performance.

The oven has five shelf positions. Count the shelf positions from the bottom of the cavity.

The oven has a special system which circulates the air and constantly recycles the steam. With this system you can cook in a

steamy environment and keep the food soft inside and crusty outside. It decreases the cooking time and energy consumption to a minimum.

Moisture can condense in the oven or on the door glass panels during cooking. Always stand back from the oven when you open the oven door.

When the oven cools down, clean the cavity with a soft cloth.

Baking cakes

Do not open the oven door before 3/4 of the set cooking time is up.

If you use two baking trays at the same time, keep one empty level between them.

Cooking meat and fish

Use a deep pan for very fatty food to prevent the oven from stains that can be permanent.

Leave the meat for approximately 15 minutes before carving so that the juice does not seep out.

To prevent too much smoke in the oven during roasting, add some water into the deep pan. To prevent the smoke condensation, add water each time after it dries up.

Cooking times

Cooking times depend on the type of food, its consistency, and volume.

Initially, monitor the performance when you cook. Find the best settings (heat setting, cooking time, etc.) for your cookware, recipes and quantities when you use this appliance.

Eco Fan Cooking



 For best results follow suggestions listed in the table below.

Food	Accessories	Temperature (°C)	Shelf position	Time (min)
Sweet rolls, 12 pieces	baking tray or dripping pan	180	2	20 - 30
Rolls, 9 pieces	baking tray or dripping pan	180	2	30 - 40
Pizza, frozen, 0.35 kg	wire shelf	220	2	10 - 15
Swiss roll	baking tray or dripping pan	170	2	25 - 35
Brownie	baking tray or dripping pan	175	3	25 - 30
Soufflè, 6 pieces	ceramic ramekins on wire shelf	200	3	25 - 30
Sponge flan base	flan base tin on wire shelf	180	2	15 - 25
Victoria Sandwich	baking dish on wire shelf	170	2	40 - 50
Poached fish, 0.3 kg	baking tray or dripping pan	180	3	20 - 25
Whole fish, 0.2 kg	baking tray or dripping pan	180	3	25 - 35

Food	Accessories	Temperature (°C)	Shelf position	Time (min)
Fish fillet, 0.3 kg	pizza pan on wire shelf	180	3	25 - 30
Poached meat, 0.25 kg	baking tray or dripping pan	200	3	35 - 45
Shashlik, 0.5 kg	baking tray or dripping pan	200	3	25 - 30
Cookies, 16 pieces	baking tray or dripping pan	180	2	20 - 30
Macaroons, 20 pieces	baking tray or dripping pan	180	2	25 - 35
Muffins, 12 pieces	baking tray or dripping pan	170	2	30 - 40
Savory pastry, 16 pieces	baking tray or dripping pan	180	2	25 - 30
Short crust biscuits, 20 pieces	baking tray or dripping pan	150	2	25 - 35
Tartlets, 8 pieces	baking tray or dripping pan	170	2	20 - 30
Poached vegetables, 0.4 kg	baking tray or dripping pan	180	3	35 - 45
Vegetarian omelette	pizza pan on wire shelf	200	3	25 - 30
Vegetables, mediterranean 0.7 kg	baking tray or dripping pan	180	4	25 - 30

Eco Fan Cooking - recommended accessories

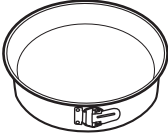
Use the dark and non-reflective tins and containers. They have better heat absorption than the light colour and reflective dishes.

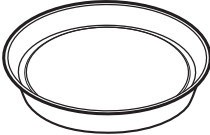
Accessories	Size	Picture
Pizza pan, dark, non-reflective	28 cm diameter	
Baking dish, dark, non-reflective	26 cm diameter	
Ramekins, ceramic	8 cm diameter, 5 cm height	
Flan base tin, dark, non-reflective	28 cm diameter	

Information for test institutes

Tests according to IEC 60350-1.

Food	Function	Accessories	Shelf position	Temperature (°C)	Time (min)	Comments
Small cake	Conventional (Top and Bottom Heat)	Baking tray	3	170	20 - 30	Put 20 small cakes per one baking tray.
Small cake	Forced Air Cooking	Baking tray	3	150 - 160	20 - 35	Put 20 small cakes per one baking tray.
Small cake	Forced Air Cooking	Baking tray	2 and 4	150 - 160	20 - 35	Put 20 small cakes per one baking tray.
Apple pie	Conventional (Top and Bottom Heat)	Wire shelf	2	180	70 - 90	Use 2 tins (20 cm diameter), diagonally shifted.

Food	Function	Accessories	Shelf position	Temperature (°C)	Time (min)	Comments
Apple pie	Forced Air Cooking	Wire shelf	2	160	70 - 90	Use 2 tins (20 cm diameter), diagonally shifted.
Fatless-ponge cake	Conventional (Top and Bottom Heat)	Wire shelf	2	170	40 - 50	Use a cake mould (26 cm diameter). Preheat the oven for 10 minutes.
Fatless-ponge cake	Forced Air Cooking	Wire shelf	2	160	40 - 50	Use a cake mould (26 cm diameter). Preheat the oven for 10 minutes.
Fatless-ponge cake	Forced Air Cooking	Wire shelf	2 and 4	160	40 - 60	Use a cake mould (26 cm diameter). Diagonally shifted. Preheat the oven for 10 minutes.
Short bread	Forced Air Cooking	Baking tray	3	140 - 150	20 - 40	-
Short bread	Forced Air Cooking	Baking tray	2 and 4	140 - 150	25 - 45	-
Short bread	Conventional (Top and Bottom Heat)	Baking tray	3	140 - 150	25 - 45	-
Toast 4 - 6 pieces	Grilling	Wire shelf	4	max.	2 - 3 minutes first side; 2 - 3 minutes second side	Preheat the oven for 3 minutes.
Beef burger 6 pieces, 0.6 kg	Grilling	Wire shelf and dripping pan	4	max.	20 - 30	Put the wire shelf on the fourth level and the dripping pan on the third level of the oven. Turn the food half-way through the cooking time. Preheat the oven for 3 minutes.

Cooking tables

For additional cooking tables please refer to the Recipe Book which you can find on the website www.ikea.com. To find the proper

Recipe Book check the article number on the rating plate on the front frame of the oven cavity.

Care and cleaning

 **Warning!** Refer to Safety chapters.

Notes on cleaning

Clean the front of the oven with a soft cloth with warm water and a mild cleaning agent.

To clean metal surfaces, use a dedicated cleaning agent.

Clean the oven interior after each use. Fat accumulation or other food remains may result in a fire. The risk is higher for the grill pan.

Clean all accessories after each use and let them dry. Use a soft cloth with warm water and a cleaning agent. Do not clean the accessories in the dishwasher.

Clean stubborn dirt with a special oven cleaner.

If you have nonstick accessories, do not clean them using aggressive agents, sharp-edged objects or a dishwasher. It can cause damage to the nonstick coating.

Moisture can condense in the oven or on the door glass panels. To decrease the condensation, operate the oven for 10 minutes before cooking. Clean the moisture from the cavity after each use.

Stainless steel or aluminium ovens

Clean the oven door with a damp cloth or sponge only. Dry it with a soft cloth.

Do not use steel wool, acids or abrasive materials as they can damage the oven surface. Clean the oven control panel with the same precautions.

Cleaning the cavity embossment

The cleaning procedure removes limestone residue from the cavity embossment after cooking with steam.

 For the function: Direct Steam we recommend to do the cleaning procedure at least every 5 - 10 cooking cycles.

1. Put 250 ml of white vinegar into the cavity embossment at the bottom of the oven.
Use maximum 6% vinegar without any additives.
2. Let the vinegar dissolve the residual limestone at the ambient temperature for 30 minutes.
3. Clean the cavity with warm water and a soft cloth.

Cleaning the door gasket

Regularly do a check of the door gasket. The door gasket is around the frame of the oven cavity. Do not use the oven if the door gasket is damaged. Contact an Authorised Service Centre.

To clean the door gasket, refer to the general information about cleaning.

Removing the shelf supports

To clean the oven, remove the shelf supports.

 **Caution!** Be careful when you remove the shelf supports.

1. Pull the front of the shelf support away from the side wall.

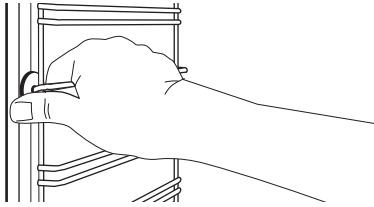

- 2. Pull the rear end of the shelf support away from the side wall and remove it.

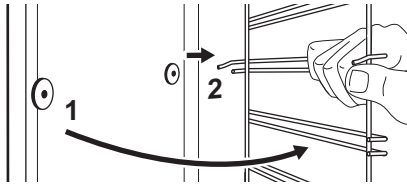

Install the removed accessories in the opposite sequence.

i The retaining pins on the telescopic runners must point to the front.

Removing and installing door

The oven door has three glass panels. You can remove the oven door and the internal glass panels to clean them. Read the whole "Removing and installing door" instruction before you remove the glass panels.

i The oven door may close if you try to remove the glass panels before you remove the oven door.

⚠ Caution! Do not use the oven without the glass panels.

- 1. Open the door fully and hold both hinges.

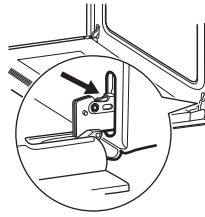

- 2. Lift and turn the levers fully on both hinges.

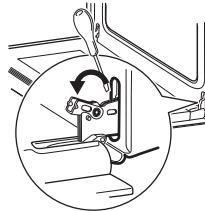

- 3. Close the oven door halfway to the first opening position. Then lift and pull forward and remove the door from its seat.

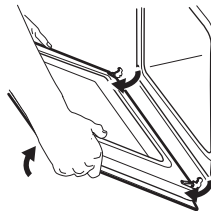

- 4. Put the door on a soft cloth on a stable surface.
- 5. Hold the door trim (B) on the top edge of the door at the two sides and push inwards to release the clip seal.

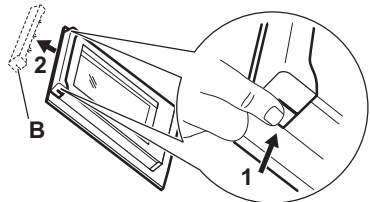

- 6. Pull the door trim to the front to remove it.
- 7. Hold the door glass panels by their top edge and carefully pull them out one by

one. Start from the top panel. Make sure the glass slides out of the supports completely.

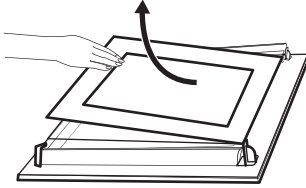

- 8. Clean the glass panels with water and soap. Dry the glass panels carefully. Do not clean the glass panels in the dishwasher.

When the cleaning is completed, install the glass panels, the door trim and the oven door, close the levers on the both hinges.

Make sure that you put the glass panels (A and B) back in the correct sequence. Check for the symbol / printing on the side of the glass panel, each of the glass panels looks different to make the disassembly and assembly easier.

The screen-printing zone must face the inner side of the door. Make sure that after the installation the surface of the glass panel frame on the screen-printing zones is not rough when you touch it.

When installed correctly the door trim clicks.

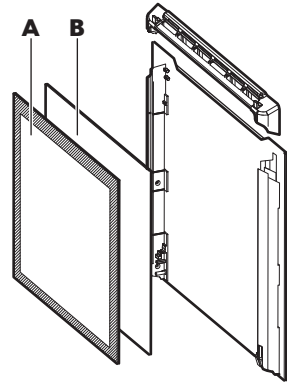

Make sure that you install the middle panel of glass in the seats correctly.

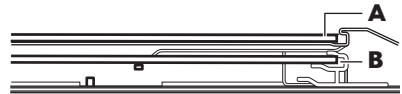

Replacing the lamp

Put a cloth on the bottom of the interior of the oven. It prevents damage to the lamp glass cover and the cavity.

Warning! Danger of electrocution! Disconnect the fuse before you replace the lamp. The lamp and the lamp glass cover can be hot.

Caution! Always hold the halogen lamp with a cloth to prevent grease residue from burning on the lamp.

1. Turn off the oven.
2. Remove the fuses from the fuse box or turn off the circuit breaker.
3. Turn the lamp glass cover counterclockwise to remove it.
4. Clean the glass cover.

- 5. Replace the oven light bulb with a 40 W, 230 V (50 Hz), 350 °C heat resistant oven light bulb (connection type: G9).
- 6. Install the glass cover.

Troubleshooting

 **Warning!** Refer to Safety chapters.

What to do if...

Problem	Possible cause	Remedy
The oven does not heat up.	The oven is deactivated.	Activate the oven.
The oven does not heat up.	The clock is not set.	Set the clock.
The oven does not heat up.	The necessary settings are not set.	Make sure that the settings are correct.
The oven does not heat up.	The automatic switch-off is activated.	Refer to "Automatic switch-off".
The oven does not heat up.	The Child Lock is on.	Refer to "Using the Child Lock".
The oven does not heat up.	The fuse is blown.	Make sure that the fuse is the cause of the malfunction. If the fuse is blown again and again, contact a qualified electrician.
The lamp does not operate.	The lamp is defective.	Replace the lamp.
Steam and condensation settle on the food and in the cavity of the oven.	You left the dish in the oven for too long.	Do not leave the dishes in the oven for longer than 15 - 20 minutes after the cooking process ends.
The display shows an error code that is not in this table.	There is an electrical fault.	<ul style="list-style-type: none"> • Deactivate the oven with the house fuse or the safety switch in the fuse box and activate it again. • If the display shows the error code again, contact an Authorised Service Centre.
There is no good cooking performance using the function: Direct Steam.	You did not turn on the function: Direct Steam.	Refer to "Activating the function: Direct Steam".

Problem	Possible cause	Remedy
There is no good cooking performance using the function: Direct Steam.	You did not fill the cavity embossment with water.	Refer to "Activating the function: Direct Steam".
The water in the cavity embossment does not boil.	The temperature is too low.	Set the temperature at least to 110 °C.
The water comes out of the cavity embossment.	There is too much water in the cavity embossment.	Deactivate the oven and make sure that the appliance is cold. Wipe the water with a cloth or sponge. Add the correct amount of water to the cavity embossment. Refer to the specific procedure.
The lamp is turned off.	The Eco Fan Cooking function is turned on.	Normal behaviour of the Eco Fan Cooking function. Refer to "Daily Use" chapter, Heating Functions.

Service data

If you cannot find a solution to the problem yourself, contact an Authorised Service Centre.

The necessary data for the service centre is on the rating plate. The rating plate is on the front frame of the oven cavity. Do not remove the rating plate from the oven cavity.

We recommend that you write the data here:	
Model (MOD.)
Product number (PNC)
Serial number (S.N.)

Technical data

Technical data

Dimensions (internal)	Width Height Depth	480 mm 361 mm 416 mm
Area of baking tray	1438 cm ²	
Top heating element	2300 W	
Bottom heating element	1000 W	

Grill	2300 W
Ring	2400 W
Total rating	2990 W
Voltage	220 - 240 V
Frequency	50 - 60 Hz
Number of functions	9

Energy efficiency

Product Information and Product Information Sheet

Supplier's name	IKEA
Model identification	SMAKSAK
Energy Efficiency Index	81.2
Energy efficiency class	A+
Energy consumption with a standard load, conventional mode	0.93 kWh/cycle
Energy consumption with a standard load, fan-forced mode	0.69 kWh/cycle
Number of cavities	1
Heat source	Electricity
Volume	72 l
Type of oven	Built-In Oven
Mass	33.1 kg

Energy saving



The oven contains features which help you save energy during everyday cooking.

General hints

Make sure that the oven door is closed properly when the oven operates. Do not open the door too often during cooking. Keep the door gasket clean and make sure it is well fixed in its position.

Use metal dishes to improve energy saving.

When possible, do not preheat the oven before you put the food inside.

When the cooking duration is longer than 30 minutes, reduce the oven temperature to minimum 3 - 10 minutes before the end of the cooking time, depending on the duration of the cooking. The residual heat inside the oven will continue to cook.

Use the residual heat to warm up other dishes.

Keep breaks between baking as short as possible when you prepare few dishes at one time.

Cooking with fan

When possible, use the cooking functions with fan to save energy.

Residual heat

If a programme with the Duration or End Time selection is activated and the cooking time is longer than 30 minutes, the heating elements automatically deactivate earlier in some oven functions.

The fan and lamp continue to operate.

Keep food warm

Choose the lowest possible temperature setting to use residual heat and keep a meal

warm. The residual heat indicator or temperature appears on the display.

Cooking with the lamp off

Turn off the lamp during cooking. Turn it on only when you need it.

Eco Fan Cooking

Function designed to save energy during cooking.

When you use this function the lamp automatically turns off after 30 seconds.

Environmental concerns

Recycle materials with the symbol . Put the packaging in relevant containers to recycle it. Help protect the environment and human health by recycling waste of electrical and electronic appliances. Do not dispose of

appliances marked with the symbol  with the household waste. Return the product to your local recycling facility or contact your municipal office.

IKEA GUARANTEE

How long is the IKEA guarantee valid?

This guarantee is valid for five (5) years from the original date of purchase of your appliance at IKEA. The original sales receipt is required as proof of purchase. If service work is carried out under guarantee, this will not extend the guarantee period for the appliance.

Who will execute the service?

IKEA service provider will provide the service through its own service operations or authorized service partner network.

What does this guarantee cover?

The guarantee covers faults of the appliance, which have been caused by faulty construction or material faults from the date

of purchase from IKEA. This guarantee applies to domestic use only. The exceptions are specified under the headline "What is not covered under this guarantee?" Within the guarantee period, the costs to remedy the fault e.g. repairs, parts, labour and travel will be covered, provided that the appliance is accessible for repair without special expenditure. On these conditions the respective local regulations are applicable. Replaced parts become the property of IKEA.

What will IKEA do to correct the problem?

IKEA appointed Service Provider will examine the product and decide, at its sole discretion, if it is covered under this guarantee. If considered covered, IKEA Service Provider or its authorized service partner through its

own service operations, will then, at its sole discretion, either repair the defective product or replace it with the same or a comparable product.

What is not covered under this guarantee?

- Normal wear and tear.
- Deliberate or negligent damage, damage caused by failure to observe operating instructions, incorrect installation or by connection to the wrong voltage, damage caused by chemical or electro-chemical reaction, rust, corrosion or water damage including but not limited to damage caused by excessive lime in the water supply, damage caused by abnormal environmental conditions.
- Consumable parts including batteries and lamps.
- Non-functional and decorative parts which do not affect normal use of the appliance, including any scratches and possible color differences.
- Accidental damage caused by foreign objects or substances and cleaning or unblocking of filters, drainage systems or soap drawers.
- Damage to the following parts: ceramic glass, accessories, crockery and cutlery baskets, feed and drainage pipes, seals, lamps and lamp covers, screens, knobs, casings and parts of casings. Unless such damages can be proved to have been caused by production faults.
- Cases where no fault could be found during a technician's visit.
- Repairs not carried out by our appointed service providers and/or an authorized service contractual partner or where non-original parts have been used.
- Repairs caused by installation which is faulty or not according to specification.
- The use of the appliance in a non-domestic environment i.e. professional use.
- Transportation damages. If a customer transports the product to his home or another address, IKEA is not liable for any damage that may occur during transport.

However, if IKEA delivers the product to the customer's delivery address, then damage to the product that occurs during this delivery will be covered by IKEA.

- Cost for carrying out the initial installation of the IKEA appliance.
- However, if an IKEA appointed Service Provider or its authorized service partner repairs or replaces the appliance under the terms of this guarantee, the appointed Service Provider or its authorized service partner will reinstall the repaired appliance or install the replacement, if necessary.
- All plumbing and electrical installation, are not the responsibility of IKEA, and customer must complete these work before the execution work.

How country law applies

The IKEA guarantee gives you specific legal rights, which cover or exceed all the local legal demands. However these conditions do not limit in any way consumer rights described in the local legislation.

Valid for INDIA only: The courts at New Dehli have exclusive jurisdiction for setting the claims or disputes or matters arising out of present Warranty.

Area of validity

This warranty is valid only in the country where the product has been purchased; the services will be provided in the framework of the guarantee conditions. An obligation to carry out services in the framework of the guarantee exists only if the appliance complies and is installed in accordance with:

- the technical specifications of the country in which the guarantee claim is made;
- the Assembly Instructions and User Manual Safety Information;

The dedicated AFTER SALES for IKEA appliances

Please don't hesitate to contact IKEA appointed Authorized Service Centre to:

- make a service request under this guarantee;

- ask for clarifications on installation of the IKEA appliance in the dedicated IKEA kitchen furniture;
- ask for clarification on functions of IKEA appliances.

documentation carefully before contacting us.

To ensure that we provide you with the best assistance, please read carefully the Assembly Instructions and/or the User Manual before contacting us.

How to reach us if you need our service



- i** The IKEA after sales customer service centre will assist you on the phone with basic troubleshooting for your appliances at the time of service call request. Please refer to **www.IKEA.com** and select your local store for local store phone numbers and opening times.
- i** Before calling us, assure that You have to hand the IKEA article number (8 digit code) and the Serial Number (8 digit code that can be found on the rating plate) for the appliance of which you need our assistance.
- i** **SAVE THE SALES RECEIPT!** It is your proof of purchase and required for the guarantee to apply. Note that the receipt reports also the IKEA article name and number (8 digit code) for each of the appliances you have purchased.

Do you need extra help?

For any additional questions not related to After Sales of your appliances please contact your nearest IKEA store call centre. We recommend you read the appliance

867360640-A-132021

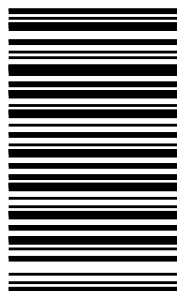

© Inter IKEA Systems B.V. 2021

21552

AA-2280241-2