

# GÖRLIG

ID

KR

205.082.48



Design and Quality  
IKEA of Sweden



**ENGLISH**

For the IKEA appointed Authorized Service Centre, please refer to [www.IKEA.com](http://www.IKEA.com) and select your local store for phone numbers and opening times.



## Contents

Safety information	4	Hints and tips	12
Safety instructions	6	Care and cleaning	16
Installation	8	Troubleshooting	18
Product description	9	Technical data	19
Before first use	9	Energy efficiency	20
Daily use	10	Environmental concerns	20
Using the accessories	11	IKEA GUARANTEE	20
Additional functions	12		

Subject to change without notice.

## Safety information

Before the installation and use of the appliance, carefully read the supplied instructions. The manufacturer is not responsible if an incorrect installation and use causes injuries and damage. Always keep the instructions with the appliance for future reference.

## Children and vulnerable people safety

- This appliance can be used by children aged from 8 years and above and persons with reduced physical, sensory or mental capabilities or lack of experience and knowledge if they have been given supervision or instruction concerning the use of the appliance in a safe way and understand the hazards involved. Children of less than 8 years of age and persons with very extensive and complex disabilities shall be kept away from the appliance unless continuously supervised.
- Children should be supervised to ensure that they do not play with the appliance.
- Keep all packaging away from children and dispose of it appropriately.

- **WARNING:** Keep children and pets away from the appliance when it operates or when it cools down. Accessible parts become hot during use.
- If the appliance has a child safety device, it should be activated.
- Children shall not carry out cleaning and user maintenance of the appliance without supervision.

## **General Safety**

- Only a qualified person must install this appliance and replace the cable.
- **WARNING:** The appliance and its accessible parts become hot during use. Care should be taken to avoid touching heating elements.
- Always use oven gloves to remove or put in accessories or ovenware.
- Before any maintenance, cut the power supply.
- **WARNING:** Ensure that the appliance is switched off before replacing the lamp to avoid the possibility of electric shock.
- Do not use the appliance before installing it in the built-in structure.
- Do not use a steam cleaner to clean the appliance.
- Do not use harsh abrasive cleaners or sharp metal scrapers to clean the glass door since they can scratch the surface, which may result in shattering of the glass.
- If the mains power supply cable is damaged, it must be replaced by the manufacturer, its Authorised Service Centre or similarly qualified persons to avoid an electrical hazard.
- The means for disconnection must be incorporated in the fixed wiring in accordance with the wiring rules.

## Safety instructions

### Installation

**⚠ Warning!** Only a qualified person must install this appliance.

- Remove all the packaging.
- Do not install or use a damaged appliance.
- Follow the installation instructions supplied with the appliance.
- Always take care when moving the appliance as it is heavy. Always use safety gloves and enclosed footwear.
- Do not pull the appliance by the handle.
- Install the appliance in a safe and suitable place that meets installation requirements.
- Keep the minimum distance from other appliances and units.
- Before mounting the appliance, check if the oven door opens without restraint.

Cabinet minimum height (Cabinet under the worktop minimum height)	580 (600) mm
Cabinet width	560 mm
Cabinet depth	550 (550) mm
Height of the front of the appliance	589 mm
Height of the back of the appliance	570 mm
Width of the front of the appliance	594 mm
Width of the back of the appliance	558 mm
Depth of the appliance	561 mm
Built in depth of the appliance	540 mm
Depth with open door	1007 mm

Ventilation opening minimum size. Opening placed on the bottom rear side	560x20 mm
Mounting screws	2x25 mm

### Electrical connection

**⚠ Warning!** Risk of fire and electric shock.

- All electrical connections should be made by a qualified electrician.
- The appliance must be earthed.
- Make sure that the parameters on the rating plate are compatible with the electrical ratings of the mains power supply.
- Always use a correctly installed shockproof socket.
- Do not use multi-plug adapters and extension cables.
- Make sure not to cause damage to the mains plug and to the mains cable. Should the mains cable need to be replaced, this must be carried out by our Authorised Service Centre.
- Do not let mains cables touch or come near the appliance door or the niche below the appliance, especially when it operates or the door is hot.
- The shock protection of live and insulated parts must be fastened in such a way that it cannot be removed without tools.
- Connect the mains plug to the mains socket only at the end of the installation. Make sure that there is access to the mains plug after the installation.
- If the mains socket is loose, do not connect the mains plug.
- Do not pull the mains cable to disconnect the appliance. Always pull the mains plug.
- Use only correct isolation devices: line protecting cut-outs, fuses (screw type fuses removed from the holder), earth leakage trips and contactors.

- The electrical installation must have an isolation device which lets you disconnect the appliance from the mains at all poles. The isolation device must have a contact opening width of minimum 3 mm.
- When installing, make sure to use a power cord and plug with KC certification with the following specifications.
  - Plug: 250 V~, 16 A
  - Power cord: 3G1.5 mm<sup>2</sup> (60227 IEC 53 or 60245 IEC 53 or IEC 60245 57)

## Use



**Warning!** Risk of injury, burns and electric shock or explosion.

- This appliance is for household (indoors) use only.
- Do not change the specification of this appliance.
- Make sure that the ventilation openings are not blocked.
- Do not let the appliance stay unattended during operation.
- Deactivate the appliance after each use.
- Be careful when you open the appliance door while the appliance is in operation. Hot air can release.
- Do not operate the appliance with wet hands or when it has contact with water.
- Do not apply pressure on the open door.
- Do not use the appliance as a work surface or as a storage surface.
- Open the appliance door carefully. The use of ingredients with alcohol can cause a mixture of alcohol and air.
- Do not let sparks or open flames to come in contact with the appliance when you open the door.
- Do not put flammable products or items that are wet with flammable products in, near or on the appliance.



**Warning!** Risk of damage to the appliance.

- To prevent damage or discoloration to the enamel:
  - do not put ovenware or other objects in the appliance directly on the bottom.

- do not put aluminium foil directly on the bottom of cavity of the appliance.
- do not put water directly into the hot appliance.
- do not keep moist dishes and food in the appliance after you finish the cooking.
- be careful when you remove or install the accessories.
- Discoloration of the enamel or stainless steel has no effect on the performance of the appliance.
- This appliance is for cooking purposes only. It must not be used for other purposes, for example room heating.
- Always cook with the oven door closed.
- If the appliance is installed behind a furniture panel (e.g. a door) make sure the door is never closed when the appliance operates. Heat and moisture can build up behind a closed furniture panel and cause subsequent damage to the appliance, the housing unit or the floor. Do not close the furniture panel until the appliance has cooled down completely after use.

## Care and Cleaning



**Warning!** Risk of injury, fire, or damage to the appliance.

- Before maintenance, deactivate the appliance and disconnect the mains plug from the mains socket.
- Make sure the appliance is cold. There is a risk that the glass panels can break.
- Replace immediately the door glass panels when they are damaged. Contact the Authorised Service Centre.
- Be careful when you remove the door from the appliance. The door is heavy!
- Clean regularly the appliance to prevent the deterioration of the surface material.
- Fat and food remaining in the appliance can cause fire.
- If you use an oven spray, obey the safety instructions on the packaging.
- Do not remove the knobs from the appliance.

**Internal lighting**

**⚠ Warning!** Risk of electric shock.

- Concerning the lamp(s) inside this product and spare part lamps sold separately: These lamps are intended to withstand extreme physical conditions in household appliances, such as temperature, vibration, humidity, or are intended to signal information about the operational status of the appliance. They are not intended to be used in other applications and are not suitable for household room illumination.
- Use only lamps with the same specifications.

**Service**

- To repair the appliance contact the Authorised Service Centre.

- Use original spare parts only.

**Disposal**

**⚠ Warning!** Risk of injury or suffocation.

- Disconnect the appliance from the mains supply.
- Cut off the mains electrical cable close to the appliance and dispose of it.
- Remove the door to prevent children and pets to get closed in the appliance.
- **Packaging material:**  
The packaging material is recyclable. Plastic parts are marked with international abbreviations such as PE, PS, etc. Dispose of the packaging material in the containers provided for this purpose at your local waste management facility.

**Installation**

**⚠ Warning!** Refer to Safety chapters.

**Assembly**

**i** Refer to the Assembly Instructions for the installation.

**Electrical installation**

**⚠ Warning!** Only a qualified person must do the electrical installation.

**i** The manufacturer is not responsible if you do not follow the safety precautions from the Safety chapters.

This oven is supplied without a main plug and a main cable.

To access the electrical connections unscrew the 2 T20 screws on the rear panel top and take the panel out.

**Cable**

Cable types applicable for installation or replacement:

H07 RN-F, H05 RN-F, H05 RRF, H05 VV-F, H05 V2V2-F (T90), H05 BB-F

For the section of the cable refer to the total power on the rating plate. You can also refer to the table:

Total power (W)	Section of the cable (mm <sup>2</sup> )
maximum 1380	3 x 0.75
maximum 2300	3 x 1
maximum 3680	3 x 1.5

The earth cord (green / yellow cable) must be 2 cm longer than phase and neutral cables (blue and brown cables).



## Product description

### General overview

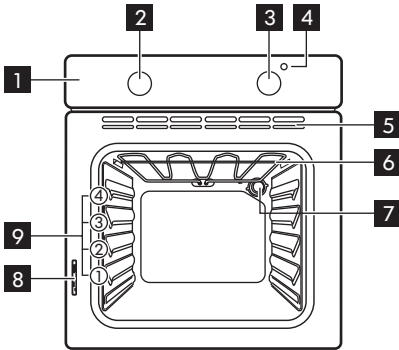

- 1 Control panel
- 2 Knob for the heating functions
- 3 Control knob
- 4 Temperature indicator
- 5 Air vents for the cooling fan
- 6 Grill
- 7 Lamp
- 8 Rating plate
- 9 Shelf positions

### Accessories

- **Wire shelf** x 1  
For cookware, cake tins, roasts.
- **Baking tray** x 1

- For cakes and biscuits.
- **Grill pan set** x 1  
To bake and roast or as pan to collect fat.

## Before first use

**Warning!** Refer to Safety chapters.

### Initial Cleaning

Remove all accessories from the oven.

**i** Refer to "Care and cleaning" chapter.

Clean the oven and the accessories before first use.

Put the accessories back to their initial position.

### Preheating

1. Set the function  and the maximum temperature.
2. Let the oven operate for 1 hour.

3. Set the function  and set the maximum temperature.
4. Let the oven operate for 15 minutes.
5. Turn off the oven and let it cool down. Accessories can become hotter than usual. The oven can emit an odour and smoke. Make sure that the airflow in the room is sufficient.

### Using the Mechanical child lock

The oven has the child lock installed. It is on the right side of the oven, below the control panel.

To open the oven door with the child lock:

1. Pull and hold the child lock handle up as shown in the picture.

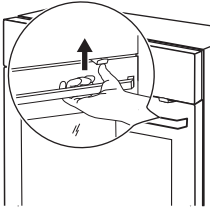

**2. Open the door.**  
 Close the oven door without pulling the child lock.  
 To remove the child lock, open the oven door and remove the child lock with the torx key. The torx key is in the oven fitting bag.

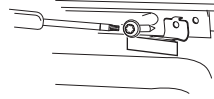

Screw back the screw into the hole after removing the child lock.

**Warning!** Be careful not to scratch the control panel.

**Daily use**

**Warning!** Refer to Safety chapters.

**Setting a heating function**



1. Turn the knob for the heating functions to select a heating function.
2. Turn the control knob to select the temperature.

The lamp turns on when the oven operates.

3. To turn off the oven, turn the knobs to the off position.

Heating function	Application
 Conventional (Top and Bottom Heat)	To bake and roast food on one shelf position.

**Heating functions**

Heating function	Application
 Off position	The oven is off.
 Bottom Heat	To bake cakes with crispy bottom and to preserve food.
 Fast Grilling	To grill flat food in large quantities and to toast bread.

Heating function	Application
 ECO Cooking	<p>This function is designed to save energy during cooking. For the cooking instructions refer to "Hints and tips" chapter, ECO Cooking. The oven door should be closed during cooking so that the function is not interrupted and to ensure that the oven operates with the highest energy efficiency possible. When you use this function, the temperature in the cavity may differ from the set temperature. The heating power may be reduced. For general energy saving recommendations refer to "Energy Efficiency" chapter, Energy Saving. This function was used to comply with the energy efficiency class according to EN 60350-1. When you use this function the lamp automatically turns off.</p>

## Using the accessories

 **Warning!** Refer to Safety chapters.

### Inserting the accessories

Wire shelf:

Push the shelf between the guide bars of the shelf support .

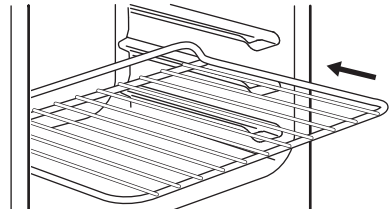

Baking tray:

Push the baking tray between the guide bars of the shelf support.

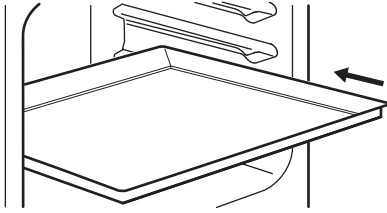

#### Grill pan set:

Put the trivet into the grill / roasting pan. Put the grill pan set onto the wire shelf or baking tray and put them into the oven at the desired shelf position.

## Additional functions

### Cooling fan

When the oven operates, the cooling fan turns on automatically to keep the surfaces of the oven cool. If you turn off the oven, the cooling fan stops.

### Safety thermostat

Incorrect operation of the oven or defective components can cause dangerous overheating. To prevent this, the oven has a safety thermostat which interrupts the power supply. The oven turns on again automatically when the temperature drops.

## Hints and tips

### Cooking recommendations

Whenever preheating, remove the wire shelves and trays from the cavity to have the fastest performance.

The oven has four shelf positions. Count the shelf positions from the bottom of the cavity.

Moisture can condense in the oven or on the door glass panels during cooking. Always stand back from the oven when you open the oven door.

When the oven cools down, clean the cavity with a soft cloth.

### Baking cakes

Do not open the oven door before 3/4 of the set cooking time is up.

### Cooking meat and fish

Leave the meat for approximately 15 minutes before carving so that the juice does not seep out.















To prevent too much smoke in the oven during roasting, add some water into the deep pan. To prevent the smoke condensation, add water each time after it dries up.

### Cooking times

Cooking times depend on the type of food, its consistency, and volume.

Initially, monitor the performance when you cook. Find the best settings (heat setting, cooking time, etc.) for your cookware, recipes and quantities when you use this appliance.

## Cooking table

Quantity (kg)	Food	Function	Shelf position	Temperature (°C)	Time (min)
1	Lamb		2	180	110 - 130
1	Veal / Beef		2	190	70 - 100
1.2	Chicken / Rabbit		2	190	70 - 80
1.5	Duck		1	160	120 - 150
3	Goose		1	160	150 - 200
4	Turkey		1	180	210 - 240
1	Fish		2	190	30 - 40
1	Stuffed pepperoni tomatoes / Roasted potatoes		2	190	50 - 70
-	Instant cakes		2	160	45 - 55
1	Pies		2	170	80 - 100
-	Biscuits		3	140	25 - 35
2	Lasagne		2	180	45 - 60
1	White bread		2	190, preheat for 10 minutes	50 - 60
1	Pizza		1	190, preheat for 10 minutes	25 - 35

## ECO Cooking

-  For best results follow suggestions listed in the table below.



Food	Accessories	Temperature (°C)	Shelf position	Time (min)
Sweet rolls, 12 pieces	baking tray or dripping pan	180	2	35 - 40

<b>Food</b>	<b>Accessories</b>	<b>Temperature (°C)</b>	<b>Shelf position</b>	<b>Time (min)</b>
Rolls, 9 pieces	baking tray or dripping pan	180	2	35 - 40
Pizza, frozen, 0.35 kg	wire shelf	220	2	35 - 40
Swiss roll	baking tray or dripping pan	170	2	30 - 40
Brownie	baking tray or dripping pan	180	2	30 - 40
Soufflè, 6 pieces	ceramic ramekins on wire shelf	200	3	30 - 40
Sponge flan base	flan base tin on wire shelf	170	2	20 - 30
Victoria Sandwich	baking dish on wire shelf	170	2	35 - 45
Poached fish, 0.3 kg	baking tray or dripping pan	180	3	35 - 45
Whole fish, 0.2 kg	baking tray or dripping pan	180	3	35 - 45
Fish fillet, 0.3 kg	pizza pan on wire shelf	180	3	35 - 45
Pouched meat, 0.25 kg	baking tray or dripping pan	200	3	40 - 50
Shashlik, 0.5 kg	baking tray or dripping pan	200	3	25 - 35
Cookies, 16 pieces	baking tray or dripping pan	180	2	20 - 30
Macaroons, 20 pieces	baking tray or dripping pan	180	2	40 - 45
Muffins, 12 pieces	baking tray or dripping pan	170	2	30 - 40
Savory pastry, 16 pieces	baking tray or dripping pan	170	2	35 - 45
Short crust biscuits, 20 pieces	baking tray or dripping pan	150	2	40 - 50

Food	Accessories	Temperature (°C)	Shelf position	Time (min)
Tartlets, 8 pieces	baking tray or dripping pan	170	2	20 - 30
Poached vegetables, 0.4 kg	baking tray or dripping pan	180	3	35 - 40
Vegetarian omelette	pizza pan on wire shelf	200	3	30 - 45
Vegetables, mediterranean 0.7 kg	baking tray or dripping pan	180	4	35 - 40

**ECO Cooking - recommended accessories**

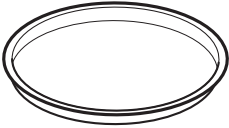
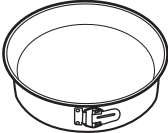
Use the dark and non-reflective tins and containers. They have better heat absorption than the light colour and reflective dishes.

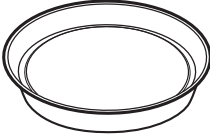
Accessories	Size	Picture
Pizza pan, dark, non-reflective	28 cm diameter	
Baking dish, dark, non-reflective	26 cm diameter	
Ramekins, ceramic	8 cm diameter, 5 cm height	
Flan base tin, dark, non-reflective	28 cm diameter	

**Information for test institutes**

Tests according to IEC 60350-1.

Food	Function	Accessories	Shelf position	Temperature (°C)	Time (min)	Comments
Small cake	Conventional (Top and Bottom Heat)	Baking tray	3	170	20 - 30	Put 20 small cakes per one baking tray.
Apple pie	Conventional (Top and Bottom Heat)	Wire shelf	1	170	80 - 120	Use 2 tins (20 cm diameter), diagonally shifted.
Sponge cake	Conventional (Top and Bottom Heat)	Wire shelf	2	170	35 - 45	Use a cake mould (26 cm diameter).
Short bread	Conventional (Top and Bottom Heat)	Baking tray	3	150	20 - 35	Preheat the oven for 10 minutes.
Toast 4 - 6 pieces	Grilling	Wire shelf	3	max.	2 - 4 minutes first side; 2 - 3 minutes second side	Preheat the oven for 3 minutes.
Beef burger 6 pieces, 0.6 kg	Grilling	Wire shelf and dripping pan	3	max.	20 - 30	Put the wire shelf on the third level and the dripping pan on the second level of the oven. Turn the food halfway through the cooking time. Preheat the oven for 3 minutes.

## Care and cleaning

 **Warning!** Refer to Safety chapters.

### Notes on cleaning

Clean the front of the oven with a soft cloth with warm water and a mild cleaning agent.

To clean metal surfaces, use a dedicated cleaning agent.

Clean the oven interior after each use. Fat accumulation or other food remains may result in a fire.

Clean all accessories after each use and let them dry. Use a soft cloth with warm water



and a cleaning agent. Do not clean the accessories in the dishwasher.

Clean stubborn dirt with a special oven cleaner.

If you have nonstick accessories, do not clean them using aggressive agents, sharp-edged objects or a dishwasher. It can cause damage to the nonstick coating.

Moisture can condense in the oven or on the door glass panels. To decrease the condensation, operate the oven for 10 minutes before cooking. Clean the moisture from the cavity after each use.

**Stainless steel or aluminium ovens**

Clean the oven door with a damp cloth or sponge only. Dry it with a soft cloth.

Do not use steel wool, acids or abrasive materials as they can damage the oven surface. Clean the oven control panel with the same precautions.

**Cleaning the door gasket**

Regularly do a check of the door gasket. The door gasket is around the frame of the oven cavity. Do not use the oven if the door gasket is damaged. Contact an Authorised Service Centre.

To clean the door gasket, refer to the general information about cleaning.

**Cleaning the oven door**

The oven door has two glass panels. You can remove the oven door and the internal glass panel to clean it.

**i** The oven door can close if you try to remove the internal glass panel before you remove the oven door.

**⚠ Caution!** Do not use the appliance without the internal glass panel.

1

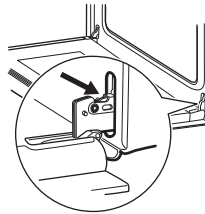

Open the door fully and hold the two door hinges.

2

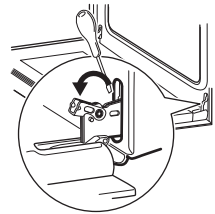

Lift and turn the levers on the two hinges with a screwdriver.

3

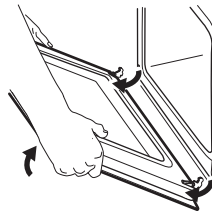

Close the oven door halfway to the first opening position. Then pull forward and remove the door from its seat.

4

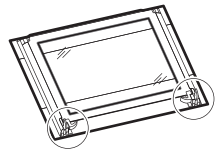

Put the door on a soft cloth on a stable surface.

5

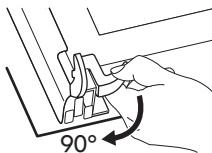

Release the locking system to remove the internal glass panel. Turn the two fasteners by 90°.

6

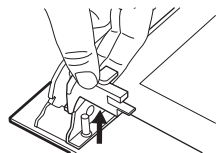

Remove the fasteners from their seats.

7

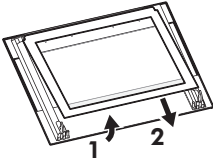

First lift carefully and then remove the glass panel.

Pull the door trim to the front to remove it

Clean the glass panel with water and soap. Dry the glass panel carefully.

When the cleaning is completed, install the glass panel and the oven door. Do the above steps in the opposite sequence.

Make sure that you install the internal glass panel in the seats correctly and in the correct sequence. The inner glass panel has a symbol printed in the corner on one side. The symbol must face the outside of the door and the external glass panel.

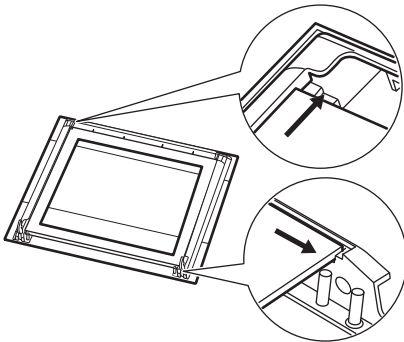

### Replacing the lamp

Put a cloth on the bottom of the interior of the oven. It prevents damage to the lamp glass cover and the cavity.

**Warning!** Danger of electrocution! Disconnect the fuse before you replace the lamp. The lamp and the lamp glass cover can be hot.

1. Turn off the oven.
2. Remove the fuses from the fuse box or turn off the circuit breaker.
3. Turn the lamp glass cover counterclockwise to remove it.
4. Clean the glass cover.
5. Replace the oven light bulb with a 25 W, 230 V (50 Hz), 300 °C heat resistant oven light bulb (connection type: E14).
6. Install the glass cover.

## Troubleshooting

**Warning!** Refer to Safety chapters.

What to do if...

Problem	Possible cause	Remedy
The oven does not heat up.	The oven is deactivated.	Activate the oven.
The oven does not heat up.	The fuse is blown.	Make sure that the fuse is the cause of the malfunction. If the fuse is blown again and again, contact a qualified electrician.
The lamp does not operate.	The lamp is defective.	Replace the lamp.
Steam and condensation settle on the food and in the cavity of the oven.	You left the dish in the oven for too long.	Do not leave the dishes in the oven for longer than 15 - 20 minutes after the cooking process ends.
The lamp is turned off.	The ECO Cookingfunction is turned on.	Normal behaviour of the ECO Cooking function. Refer to "Daily Use" chapter, Heating Functions.

Service data

If you cannot find a solution to the problem yourself, contact an Authorised Service Centre.

The necessary data for the service centre is on the rating plate. The rating plate is on the front frame of the oven cavity. Do not remove the rating plate from the oven cavity.

We recommend that you write the data here:	
Model (MOD.)	.....
Product number (PNC)	.....
Serial number (S.N.)	.....

Technical data

Technical data

Dimensions (internal)	Width Height Depth	408 mm 329 mm 417 mm
Area of baking tray	1140 cm <sup>2</sup>	
Top heating element	800 W	
Bottom heating element	1000 W	

Grill	1650 W
Total rating	2500 W
Voltage	220 - 240 V
Frequency	50 Hz
Number of functions	4

## Energy efficiency

### Energy saving



The oven contains features which help you save energy during everyday cooking.

### General hints

Make sure that the oven door is closed properly when the oven operates. Do not open the door too often during cooking. Keep the door gasket clean and make sure it is well fixed in its position.

Use metal dishes to improve energy saving.

When possible, do not preheat the oven before you put the food inside.

When the cooking duration is longer than 30 minutes, reduce the oven temperature to minimum 3 - 10 minutes before the end of the cooking time, depending on the duration

of the cooking. The residual heat inside the oven will continue to cook.

Use the residual heat to warm up other dishes.

Keep breaks between baking as short as possible when you prepare few dishes at one time.

### Keep food warm

Choose the lowest possible temperature setting to use residual heat and keep a meal warm.

### ECO Cooking

Function designed to save energy during cooking.

When you use this function the lamp automatically turns off.

## Environmental concerns

Recycle materials with the symbol . Put the packaging in relevant containers to recycle it. Help protect the environment and human health by recycling waste of electrical and electronic appliances. Do not dispose of

appliances marked with the symbol  with the household waste. Return the product to your local recycling facility or contact your municipal office.

## IKEA GUARANTEE

### How long is the IKEA guarantee valid?

This guarantee is valid for five (5) years from the original date of purchase of your

appliance at IKEA. The original sales receipt is required as proof of purchase. If service work is carried out under guarantee, this will

not extend the guarantee period for the appliance.

#### **Who will execute the service?**

IKEA service provider will provide the service through its own service operations or authorized service partner network.

#### **What does this guarantee cover?**

The guarantee covers faults of the appliance, which have been caused by faulty construction or material faults from the date of purchase from IKEA. This guarantee applies to domestic use only. The exceptions are specified under the headline "What is not covered under this guarantee?" Within the guarantee period, the costs to remedy the fault e.g. repairs, parts, labour and travel will be covered, provided that the appliance is accessible for repair without special expenditure. On these conditions the respective local regulations are applicable. Replaced parts become the property of IKEA.

#### **What will IKEA do to correct the problem?**

IKEA appointed Service Provider will examine the product and decide, at its sole discretion, if it is covered under this guarantee. If considered covered, IKEA Service Provider or its authorized service partner through its own service operations, will then, at its sole discretion, either repair the defective product or replace it with the same or a comparable product.

#### **What is not covered under this guarantee?**

- Normal wear and tear.
- Deliberate or negligent damage, damage caused by failure to observe operating instructions, incorrect installation or by connection to the wrong voltage, damage caused by chemical or electro-chemical reaction, rust, corrosion or water damage including but not limited to damage caused by excessive lime in the water supply, damage caused by abnormal environmental conditions.
- Consumable parts including batteries and lamps.

- Non-functional and decorative parts which do not affect normal use of the appliance, including any scratches and possible color differences.
- Accidental damage caused by foreign objects or substances and cleaning or unblocking of filters, drainage systems or soap drawers.
- Damage to the following parts: ceramic glass, accessories, crockery and cutlery baskets, feed and drainage pipes, seals, lamps and lamp covers, screens, knobs, casings and parts of casings. Unless such damages can be proved to have been caused by production faults.
- Cases where no fault could be found during a technician's visit.
- Repairs not carried out by our appointed service providers and/or an authorized service contractual partner or where non-original parts have been used.
- Repairs caused by installation which is faulty or not according to specification.
- The use of the appliance in a non-domestic environment i.e. professional use.
- Transportation damages. If a customer transports the product to his home or another address, IKEA is not liable for any damage that may occur during transport. However, if IKEA delivers the product to the customer's delivery address, then damage to the product that occurs during this delivery will be covered by IKEA.
- Cost for carrying out the initial installation of the IKEA appliance.
- However, if an IKEA appointed Service Provider or its authorized service partner repairs or replaces the appliance under the terms of this guarantee, the appointed Service Provider or its authorized service partner will reinstall the repaired appliance or install the replacement, if necessary.
- All plumbing and electrical installation, are not the responsibility of IKEA, and customer must complete these work before the execution work.

#### **How country law applies**

The IKEA guarantee gives you specific legal rights, which cover or exceed all the local legal demands. However these conditions do not limit in any way consumer rights described in the local legislation.

Valid for INDIA only: The courts at New Dehli have exclusive jurisdiction for setting the claims or disputes or matters arising out of present Warranty.

**Area of validity**

This warranty is valid only in the country where the product has been purchased; the services will be provided in the framework of the guarantee conditions. An obligation to carry out services in the framework of the guarantee exists only if the appliance complies and is installed in accordance with:

- the technical specifications of the country in which the guarantee claim is made;
- the Assembly Instructions and User Manual Safety Information;

**The dedicated AFTER SALES for IKEA appliances**

Please don't hesitate to contact IKEA appointed Authorized Service Centre to:

- make a service request under this guarantee;
- ask for clarifications on installation of the IKEA appliance in the dedicated IKEA kitchen furniture;
- ask for clarification on functions of IKEA appliances.

To ensure that we provide you with the best assistance, please read carefully the Assembly Instructions and/or the User Manual before contacting us.

**How to reach us if you need our service**



**i** The IKEA after sales customer service centre will assist you on the phone with basic trouble-shooting for your appliances at the time of service call request. Please refer to **www.IKEA.com** and select your local store for local store phone numbers and opening times.

**i** Before calling us, assure that You have to hand the IKEA article number (8 digit code) and the Serial Number (8 digit code that can be found on the rating plate) for the appliance of which you need our assistance.

**i** **SAVE THE SALES RECEIPT!** It is your proof of purchase and required for the guarantee to apply. Note that the receipt reports also the IKEA article name and number (8 digit code) for each of the appliances you have purchased.

**Do you need extra help?**

For any additional questions not related to After Sales of your appliances please contact your nearest IKEA store call centre. We recommend you read the appliance documentation carefully before contacting us.



867368145-C-242021

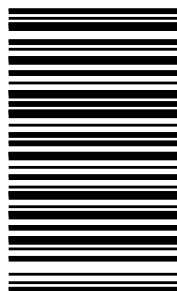

© Inter IKEA Systems B.V. 2021

21552

AA-2283019-2